



# NSO evo3

# Operator Manual

ENGLISH





# Preface

---

## Disclaimer

As Navico is continuously improving this product, we retain the right to make changes to the product at any time which may not be reflected in this version of the manual. Please contact your nearest distributor if you require any further assistance.

It is the owner's sole responsibility to install and use the equipment in a manner that will not cause accidents, personal injury or property damage. The user of this product is solely responsible for observing maritime safety practices.

NAVICO HOLDING AS AND ITS SUBSIDIARIES, BRANCHES AND AFFILIATES DISCLAIM ALL LIABILITY FOR ANY USE OF THIS PRODUCT IN A WAY THAT MAY CAUSE ACCIDENTS, DAMAGE OR THAT MAY VIOLATE THE LAW.

This manual represents the product as at the time of printing. Navico Holding AS and its subsidiaries, branches and affiliates reserve the right to make changes to specifications without notice.

## Governing language

This statement, any instruction manuals, user guides and other information relating to the product (Documentation) may be translated to, or has been translated from, another language (Translation). In the event of any conflict between any Translation of the Documentation, the English language version of the Documentation will be the official version of the Documentation.

## Trademarks

Navico<sup>®</sup> is a registered trademark of Navico.

Simrad<sup>®</sup> is used by license from Kongsberg.

Additional mapping data: Copyright© 2012 NSI, Inc.: Copyright© 2012 by Richardson's Maptech.

Bluetooth<sup>®</sup> is a registered trademark of Bluetooth SIG, Inc.

C-MAP<sup>®</sup> is a registered trademark of C-MAP.

FLIR<sup>®</sup> is a registered trademark of FLIR.

FUSION-Link™ Marine Entertainment Standard™ is a registered trademark of FUSION Electronics Ltd.

HDMI<sup>®</sup> and HDMI™, the HDMI Logo, and High-Definition Multimedia Interface are trademarks or registered trademarks of HDMI Licensing LLC in the United States and other countries.

Mercury<sup>®</sup> is a registered trademark of Mercury.

Navionics<sup>®</sup> is a registered trademark of Navionics, Inc.

NMEA<sup>®</sup> and NMEA 2000<sup>®</sup> are registered trademarks of the National Marine Electronics Association.

SiriusXM<sup>®</sup> is a registered trademark of Sirius XM Radio Inc.

SmartCraft VesselView<sup>®</sup> is a registered trademark of Mercury.

Suzuki<sup>®</sup> is a registered trademark of Suzuki.

Wi-Fi<sup>®</sup> is a registered trademark of the Wi-Fi Alliance<sup>®</sup>.

Yamaha<sup>®</sup> is a registered trademark of Yamaha.

## Navico product references

This manual refers to the following Navico products:

- Broadband Radar™ (Broadband Radar)
- Broadband 3G™ (Broadband 3G Radar)
- Broadband 4G™ (Broadband 4G Radar)
- Broadband Sounder™ (Broadband Sounder)
- DownScan Imaging™ (DownScan)
- DownScan Overlay™ (Overlay)
- ForwardScan™ (ForwardScan)

- GoFree™ (GoFree)
- Halo™ Pulse Compression Radar (Halo Radar)
- SmartSteer™ (SmartSteer)
- SonicHub® (SonicHub)
- StructureMap™ (StructureMap)
- StructureScan® (StructureScan)
- StructureScan® HD (StructureScan HD)

## Copyright

Copyright © 2018 Navico Holding AS.

## Warranty

The warranty card is supplied as a separate document. In case of any queries, refer to the brand website of your unit or system: [www.simrad-yachting.com](http://www.simrad-yachting.com).

## Compliance statements

This equipment complies with:

- CE under 2014/53/EU Directive
- The requirements of level 2 devices of the Radio communications (Electromagnetic Compatibility) standard 2008
- Part 15 of the FCC Rules. Operation is subject to the following two conditions: (1) this device may not cause harmful interference, and (2) this device must accept any interference received, including interference that may cause undesired operation.

The relevant Declaration of Conformity is available in the product's section at the following website: [www.simrad-yachting.com](http://www.simrad-yachting.com).

## Industry Canada

This device complies with Industry Canada license-exempt RSS standard(s). Operation is subject to the following two conditions: (1) this device may not cause interference, and (2) this device must accept any interference, including interference that may cause undesired operation of the device.

Le présent appareil est conforme aux CNR d'Industrie Canada applicables aux appareils radio exempts de licence. L'exploitation est autorisée aux deux conditions suivantes: (1) l'appareil ne doit pas produire de brouillage, et (2) l'utilisateur de l'appareil doit accepter tout brouillage radioélectrique subi, même si le brouillage est susceptible d'en compromettre le fonctionnement.

## Internet usage

Some features in this product use an internet connection to perform data downloads and uploads. Internet usage via a connected mobile/cell phone internet connection or a pay-per-MB type internet connection may require large data usage. Your service provider may charge you based on the amount of data you transfer. If you are unsure, contact your service provider to confirm rates and restrictions.

## About this manual

This manual is a reference guide for operating the unit. It assumes that all equipment is installed and configured, and that the system is ready to use.

Some features may not be activated or available for screenshots in the manual. As a result, screenshots of menus and dialogs may not match the look of your unit.

Important text that requires special attention from the reader is emphasized as follows:

→ **Note:** Used to draw the reader's attention to a comment or some important information.



**⚠ Warning:** Used when it is necessary to warn personnel that they should proceed carefully to prevent risk of injury and/or damage to equipment/personnel.

## Manual version

This manual is written for software version 1.0. The manual is continually updated to match new software releases. The latest available manual version can be downloaded from [www.simrad-yachting.com](http://www.simrad-yachting.com).

## Viewing the manual on the screen

The PDF viewer included in the unit makes it possible to read the manuals and other PDF files on the screen. Manuals can be downloaded from [www.simrad-yachting.com](http://www.simrad-yachting.com).

The manuals can be read from a storage device connected to the unit or copied to the unit's internal memory.

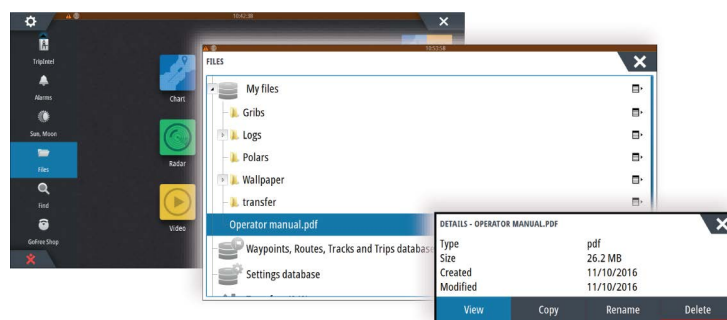

## The Software version

The software version currently on this unit can be found in the About dialog. The About dialog is available in the System Settings.

For information regarding upgrading your software, refer to "*Software upgrades*" on page 132.

# Contents

---

<b>11</b>	<b>Introduction</b>
11	Front controls
11	The Home page
12	Application pages
13	Integration of 3 <sup>rd</sup> party devices
15	Feature unlock
15	Card reader
15	USB devices
16	Remote controllers
<b>17</b>	<b>Basic operation</b>
17	System controls dialog
17	Turning the system on and off
17	Standby mode
17	Display illumination
17	Locking the touchscreen
18	Wireless
18	Instrument bar
18	Touchscreen, keyboard and mouse operation
18	Menus
18	Pages and panels
18	Favorite panel as pop-up on a page
18	Man Overboard waypoint
19	Screen capture
<b>20</b>	<b>Customizing your system</b>
20	Customizing the Home page wallpaper
20	Configurable WheelKey
20	Customizing the long press feature
20	Adjusting panel size
21	Password protection
21	Adding new favorite pages
22	Edit favorite pages
22	Setting the appearance of the Instrument bar
23	Bridge Control
<b>26</b>	<b>Charts</b>
26	The Chart panel
26	Chart data
26	Showing dual chart types
27	Panning the chart
27	Chart scale
27	Vessel symbol
27	Positioning the vessel on the chart panel
28	Displaying information about chart items
28	Using the cursor on the chart panel
29	Saving waypoints
29	Creating routes
29	Find objects on chart panels
30	Marine Search and Rescue (SAR) feature
31	3D charts
31	Chart overlay
32	Insight and C-MAP charts
35	Navionics charts
39	Chart settings

<b>41</b>	<b>Waypoints, Routes, and Tracks</b>
41	Waypoints
42	Routes
44	Tracks
46	Waypoints, Routes, and Tracks dialogs
<b>47</b>	<b>Navigating</b>
47	Navigation panels
48	Navigate to cursor position
48	Navigate a route
49	Navigating with the autopilot
49	Navigation settings
<b>51</b>	<b>Triptel</b>
51	Current trip statistics
51	Automatic trip recording
52	Start and stop trip recordings
52	Long-term statistics
52	Estimated fuel range ring
52	Fuel gauge
53	Tide gauge
53	View trip recordings
<b>55</b>	<b>Autopilot</b>
55	Safe operation with the autopilot
55	Activating the autopilot
55	Switching from automatic mode to manual steering
55	Autopilot indication on the pages
56	The Autopilot panel
57	Autopilot modes
57	Standby mode
57	Non-Follow Up (NFU, Power steering)
57	Follow-up steering (FU)
57	Heading hold
58	NoDrift mode
58	NAV mode
59	WIND mode
60	Turn pattern steering
62	Using the autopilot in an EVC system
62	Using the NSO evo3 in an AP70/AP80 system
65	Autopilot settings
<b>69</b>	<b>Radar</b>
69	The radar panel
69	Dual radar
70	Radar overlay
70	Radar operational modes
70	Radar Range
71	Using the cursor on a radar panel
71	Saving waypoints
71	Radar sector blanking
72	Adjusting the radar image
74	Advanced radar options
75	Radar view options
78	EBL/VRM markers
79	Setting a guard zone around your vessel
79	MARPA targets
80	Recording radar data

81	Radar settings
<b>82</b>	<b>Echosounder</b>
82	The Echosounder image
82	Multiple Echosounder
83	Zooming the image
83	Using the cursor on the image
84	Viewing history
84	Setting up the image
85	Advanced options
86	Start recording log data
87	Stop recording log data
87	Viewing the recorded sounder data
87	Echosounder View options
88	Echosounder settings
<b>90</b>	<b>StructureScan</b>
90	The StructureScan image
90	Zooming the StructureScan image
91	Using the cursor on the StructureScan panel
91	Viewing StructureScan history
92	Setting up the StructureScan image
92	Advanced StructureScan settings
<b>94</b>	<b>StructureMap</b>
94	The StructureMap image
94	Activating Structure overlay
94	StructureMap sources
95	StructureMap tips
95	Recording StructureScan data
95	Using StructureMap with mapping cards
95	Structure options
<b>97</b>	<b>ForwardScan</b>
97	The ForwardScan image
98	Setting up the ForwardScan image
98	ForwardScan view options
98	Heading extension
99	ForwardScan setup
<b>102</b>	<b>Wireless connection</b>
102	Connect and disconnect from a wireless hotspot
102	GoFree Shop
102	GoFree Link
103	Uploading log files to C-MAP Genesis
103	Wireless settings
<b>105</b>	<b>AIS</b>
105	AIS target symbols
105	Viewing information about AIS targets
106	Calling an AIS vessel
106	AIS SART
107	Vessel alarms
108	Vessel settings
<b>110</b>	<b>Instrument panels</b>
110	Dashboards
110	Customizing the Instruments panel

## **111 Audio**

- 111 Enabling audio
- 111 Operating the audio system
- 111 The Audio controller
- 113 Setting up the audio system
- 114 Pairing audio servers
- 115 Sirius radio (North America only)

## **116 Weather**

- 116 Wind barbs
- 116 Showing weather details
- 116 GRIB weather
- 118 SiriusXM weather
- 121 Weather alarms

## **122 Video**

- 122 The Video panel
- 122 Setting up the video panel
- 122 FLIR camera control

## **124 Time plots**

- 124 The Time plot panel
- 124 Selecting data

## **125 Alarms**

- 125 Alarm system
- 125 Type of messages
- 125 Single alarms
- 125 Multiple alarms
- 125 Acknowledging a message
- 125 Alarms settings

## **127 Tools**

- 127 Waypoints
- 127 Tides
- 127 Alarms
- 127 Vessels
- 127 TripIntel
- 127 Sun, Moon
- 127 Files
- 128 Find
- 128 GoFree Shop

## **129 Simulator**

- 129 Demo mode
- 129 Simulator source files
- 129 Advanced simulator settings

## **131 Maintenance**

- 131 Preventive maintenance
- 131 Cleaning the display unit
- 131 Checking the connectors
- 131 NMEA Data logging
- 132 Software upgrades
- 133 Backing up your system data

## **135 Appendix**

- 135 Touchscreen operation
- 135 Key operation overview
- 136 Using the mouse to control the system
- 137 Status bar icon definitions

# 1

## Introduction

### Front controls

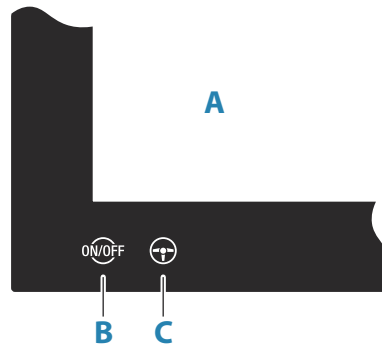

#### A Touch screen

#### B Power key

- Press and hold: turns the unit ON/OFF
- Short press once: displays the System Controls dialog
- Repeat short presses: toggles through preset dimming levels

#### C WheelKey - user configurable key, refer to "Configurable WheelKey" on page 20.

Default without an autopilot connected to the system

- Short press: toggles between panels on split screen
- Long press: maximizes active panel on split screen

Default with an autopilot connected to the system

- Short press: opens the autopilot controller and puts the autopilot in standby mode
- Long press: toggles between panels on split screen

### The Home page

The **Home** page is accessed from any operation by selecting the **Home** button in the upper left corner of a panel, or the **PAGES** key on a remote controller.



#### 1 Applications

Select a button to display the application as a full page panel.

Press and hold a button to display pre-configured split page options for the application.

- 2 Settings button**  
Select to access Settings dialogs.
- 3 Tools**  
Select a button to access dialogs used for carrying out a task, or for browsing stored information.
- 4 Favorites**  
Select a button to display the panel combination.  
Press and hold a favorite button to enter edit mode for the Favorites panel.
- 5 Close button**  
Select to exit the **Home** page and return to the previous active page.
- 6 Power button**  
Select to power off the unit.
- 7 Man Over Board (MOB) button**  
Select to save a Man Over Board (MOB) waypoint at the current vessel position.

## Application pages

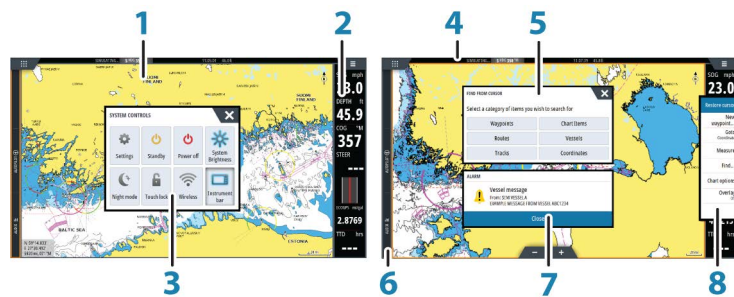

- 1 Application panel**
- 2 Instrument bar**  
Navigation and sensor information. The bar can be turned off and it can be configured by the user.
- 3 System controls dialog**  
Quick access to basic system settings.  
Display the dialog by a short press on the Power key or by swiping down from top of the screen.
- 4 Status bar**  
Displays time and date, and status of the system, features, and items connected to the unit. Refer to "*Status bar icon definitions*" on page 137.
- 5 Dialog**  
Information to or input from the user.
- 6 Control bar**  
Select a feature button to display controls for it.
- 7 Alarm message**  
Displayed if dangerous situations or system faults occur.
- 8 Menu**  
Panel specific menu.  
Display the menu by selecting the **MENU** panel button, or by pressing the **MENU** key on a remote controller.

Each application connected to the system is presented on panels.

The application can be presented as a full page, or in combination with other panels in a multiple panel page.

All application pages are accessed from the Home page.



## Split pages

You can have up to 6 panels on a multiple panel page.

Panel sizes in a multiple panel page can be adjusted from the System Controls dialog. Refer to *"Adjusting panel size"* on page 20.

To use a panel menu, you must first activate the panel. Select a panel to activate it. An active panel is indicated with an orange border. You can then select the menu icon to display the menu for the active panel.

The following are examples of split pages.

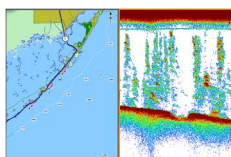

2 panels page

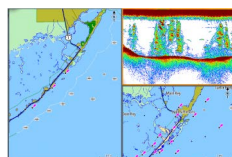

3 panels page

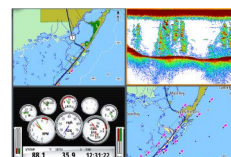

4 panels page

### Using the cursor on a split screen

When using the cursor on the sonar or structure image on a sonar/structure or sonar/chart split screen, the cursor is shadowed on the other split screen.

### Pre-configured split pages

Each full screen application has several pre-configured split pages, featuring the selected application combined with each of the other panels.

→ **Note:** The number of pre-configured split pages cannot be changed, and the pages cannot be customized or deleted.

Access a pre-configured split page by pressing and holding the main panel button.

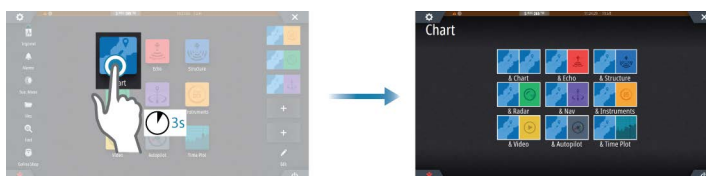

### Favorite pages

All preconfigured favorite pages can be modified and deleted, and you can create your own. You can have a total of 12 favorite pages.

For more information, refer to *"Adding new favorite pages"* on page 21.

## Integration of 3<sup>rd</sup> party devices

Several 3<sup>rd</sup> party devices can be connected to the NSO evo3. The applications are displayed on separate panels or integrated with other panels.

A device connected to the NMEA 2000 network should automatically be identified by the system. If not, enable the feature from the advanced option in the System settings dialog.

The 3<sup>rd</sup> party device is operated by using menus and dialogs as on other panels.

This manual does not include specific operation instructions for any 3<sup>rd</sup> party device. For features and functionality, refer to the documentation included with the 3<sup>rd</sup> party device.

### SmartCraft VesselView integration

SmartCraft data can be displayed and interaction are enabled through the unit when a compatible Mercury Marine VesselView product or VesselView Link is present on the network.

The Mercury icon appears on the Home page when a device is available. Mercury and Vessel Control buttons are also available on the Control bar. Selecting the Mercury control bar

button displays engine and vessel data, selecting the Vessel Control button displays engine controls associated with VesselView.

When the features are enabled, the display may prompt the user for some basic configuration information.

For more information about configuration information, the Mercury application page, the Mercury engine and vessel data displayed, and the Vessel Control controller, refer to the VesselView manual or engine supplier.

### **Suzuki Engine panel**

If a Suzuki engine adapter is available on the NMEA 2000 network, a Suzuki engine icon is added to the **Home** page. An icon is also added to the Page editor. You can select to display the Suzuki engine panel as a full page panel or as part of a multi-panel page.

The layout and content of the engine panel depends on selected panel size. The digital gauges can be customized, refer to "*Customizing the panel*" on page 110.

### **Yamaha engine integration**

If a compatible Yamaha gateway is connected to the NMEA 2000 network, a Yamaha engine icon is added to the Home page. An icon is also added to the Page editor. You can select to display the Yamaha engine panel as a full page panel or as part of a multi-panel page. The layout and content of the engine panel depends on the panel size.

If the Yamaha system supports Troll Control, a Troll button is added to the Control Bar. Select this button to enable/disable troll control and control the trolling speed.

For more information about configuration information, the Yamaha panel and the data displayed, and Troll control, refer to the Yamaha manual or the engine supplier.

### **FUSION-Link integration**

FUSION-Link devices connected to the NMEA 2000 network can be controlled from the NSO evo3 system.

The FUSION-Link devices appear as additional sources when using the audio function. No additional icons are available.

Refer to "*Audio*" on page 111 for more information.

### **FLIR camera integration**

If a compatible FLIR M-series camera is available on the Ethernet network, you can display the video and control the camera from the NSO evo3.

The FLIR camera is controlled from the Video panel, and no additional icons appear on the Home page.

Refer to "*Video*" on page 122 for more information.

### **BEP CZone integration**

The unit integrates with BEP's CZone system used for controlling and monitoring a distributed power system on your vessel.

The CZone icon is available in the Tools panel on the Home page when a CZone system is available on the network.

A separate manual is provided with your CZone system. Refer to this documentation and to the unit's Installation manual for how to install and configure the CZone system.

#### **CZone dashboard**

When the CZone is installed and configured, an additional CZone dashboard is added to the Instruments panels.

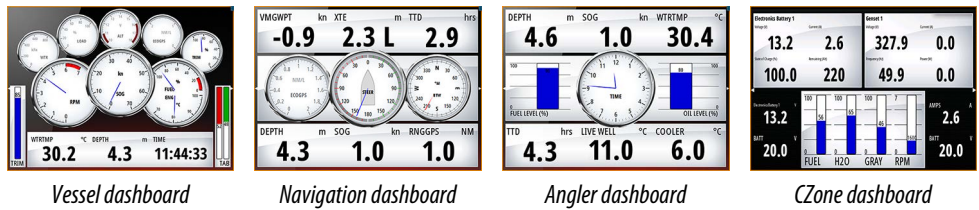

Vessel dashboard

Navigation dashboard

Angler dashboard

CZone dashboard

You switch between a panel's dashboards by selecting the left and right arrow symbols or by selecting the dashboard from the menu.

### Editing a CZone dashboard

You can customize a CZone dashboard by changing the data for each of the gauges. Available editing options depend on the type of gauge and which data sources that are connected to your system.

For more information, refer to "Instrument panels" on page 110.

## Feature unlock

Features can be unlocked by entering the feature unlock code.

→ **Note:** The Feature Unlock option is only available if your unit supports a locked feature.

Select the Feature Unlock option in the Settings dialog and then the feature you want to unlock. Follow the instructions to purchase and enter the feature unlock code.

After a feature unlock code is entered in the unit, the feature is available for use.

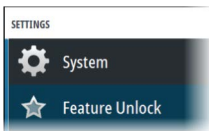

## Card reader

A memory card can be used for detailed chart data, software updates, transfer of user data, and system backup.

→ **Note:** Do not download, transfer or copy files to a chart card. Doing so can damage chart information on the chart card.

If the card reader has a protective door it should always be securely shut immediately after inserting or removing a card, in order to prevent possible water ingress.

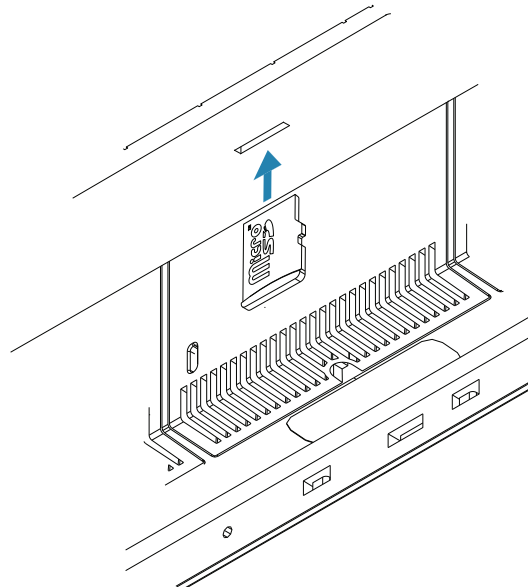

## USB devices

The USB ports can be used to connect a keyboard, mouse or storage device for software updates, transfer of user data, and system backup. The USB devices should be standard PC compatible hardware.

→ **Note:** USB cable length should not exceed 5 m when using regular cables. Lengths over 5 m may be possible with the use of an active USB cable.

## Remote controllers

You can connect a remote controller to the network and remotely control the unit. To find out which remote controllers can be used, refer to the product web page at:

[www.simrad-yachting.com](http://www.simrad-yachting.com).

A separate manual is included with the remote controller.

# 2

## Basic operation

### System controls dialog

The System Controls dialog provides quick access to basic system settings.

Display the dialog by making a short press on the Power key.

The icons displayed on the dialog vary with operational mode and connected equipment.



### Activating functions

Select the icon of the function you want to set or toggle on or off. For those functions that toggle on and off, a highlighted icon indicates the function is activated, as shown in the Instrument bar icon above.

### Turning the system on and off

The system is turned on by pressing the Power key.

Press and hold the Power key to turn the unit off.

If the Power key is released before the shut-down is completed, the power off process is cancelled.

### First time startup

When the unit is started for the first time, or after a factory default, the unit displays a series of dialogs. Respond to the dialog prompts to make fundamental settings.

You can perform further setup and later change settings using the system settings dialogs.

### Standby mode

In Standby mode, the backlight for screen and keys are turned off to save power. The system continues to run in the background.

You select Standby mode from the System Controls dialog.

Switch from Standby mode to normal operation by a short press on the Power key.

### Display illumination

#### Brightness

You can cycle the preset backlight levels by short presses on the Power key.

#### Night mode

The night mode option optimizes the color palette and backlight for low light conditions.

### Locking the touchscreen

You can temporarily lock a touch screen to prevent accidental operation of the system.

You lock the touch screen from the System Controls dialog.

When the touch lock is active you can still operate the unit from the keys or remote controller.

You remove the lock function by pressing on the Power key on the unit or remote controller.

## Wireless

Provides wireless connection options dependent on the status of the wireless. For example, connect to a hotspot or change it to be an access point. For option explanations refer to *"Wireless connection"* on page 102.

## Instrument bar

Toggles the Instrument bar on/off for the current page only.

## Touchscreen, keyboard and mouse operation

For touchscreen, keyboard and mouse operation details, refer to the *"Appendix"* on page 135.

## Menus

To display a page menu:

- Select the Menu button

To return to previous menu level:

- Select the Back menu option

To hide a page menu:

- Tap the screen outside the menu area

## Pages and panels

Pages are selected from the Home page.

Full page panels:

- Select the relevant application button

Favorite pages:

- Select the relevant favorite button

Predefined split pages:

- Press and hold the relevant application icon

In a multiple panel page, only one panel can be active at a time. The active panel is outlined with a border. You can only access the page menu of an active panel.

To select active panel in a multiple panel page:

- Tap the panel
- Press the Ctrl + D keys on a keyboard
- Press the Win key on a remote controller

## Favorite panel as pop-up on a page

The favorite panel can be displayed on any page.

To display the favorite panel:

- Press and holding the Home button
- Press and holding the Pages key on a remote controller
- Press the Ctrl and ; on a keyboard

## Man Overboard waypoint

If an emergency situation should occur, you can save a Man Overboard (MOB) waypoint at the vessel's current position.

To create a Man Overboard (MOB) waypoint:

- Select the MOB button on the Home page
- Press the MOB key on a remote controller

- Press and hold the F12 key on a keyboard

When you activate the MOB function the following actions are automatically performed:

- A MOB waypoint is created at the vessel's position
- The display switches to a zoomed chart panel, centered on the vessel's position
- The system displays navigation information back to the MOB waypoint

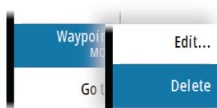

Multiple MOB waypoints can be created. The vessel continues to show navigation information to the initial MOB waypoint. Navigation to subsequent MOB waypoints needs to be done manually.

The system continues to display navigational information towards the MOB waypoint until you cancel the navigation from the menu.

A MOB waypoint can be deleted from the menu when it is activated.

## Screen capture

You enable/disable the Screen capture option in the System settings dialog.

To take a screen capture:

- Tap the status bar or the dialog title

# 3

## Customizing your system

### Customizing the Home page wallpaper

The Home page's wallpaper can be customized. You can select one of the pictures included with the system, or you can use your own picture in .jpg or .png format.

The images can be available on any location that can be seen in the files browser. When a picture is chosen as the wallpaper, it is automatically copied to the Wallpaper folder.

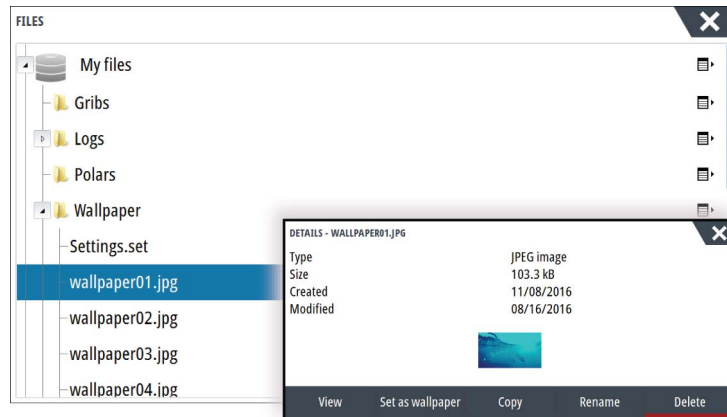
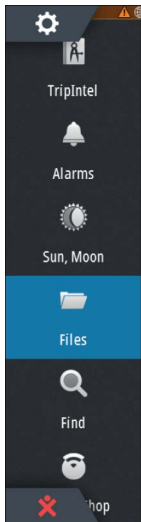

### Configurable WheelKey

Configures the action of the WheelKey on the front of the unit.

To configure the Wheel key, select Configure WheelKey on the System Setting dialog.

### Customizing the long press feature

Use the **Advanced settings** dialog to specify if the long press on the panel opens the menu or displays the cursor assist feature on the panel.

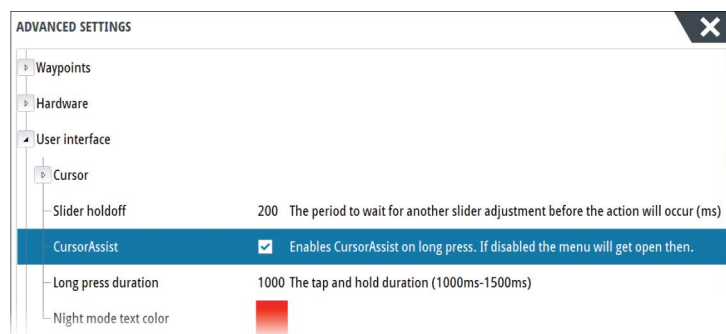

### Adjusting panel size

You can change the panel size for an active split page. The panel size can be adjusted for both favorite pages and for predefined split pages.

1. Activate the System Controls dialog
2. Select the adjust splits option in the dialog
3. Adjust the panel size by selecting the adjustment icon and moving it to the desired position. The direction the adjustment icon can be moved depends on the layout.
4. Use menu options to save or discard your changes.



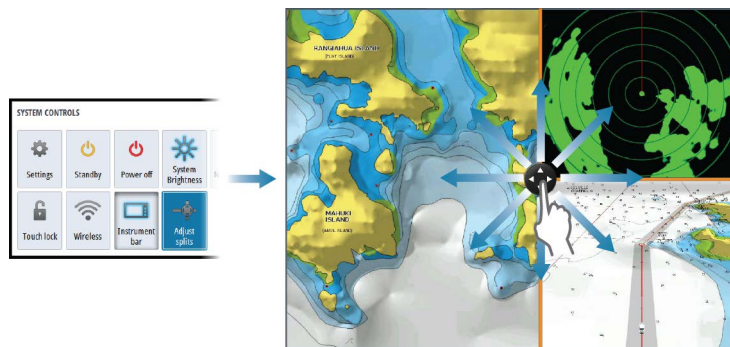

The changes are saved to the active favorite or split page.

## Password protection

You can set a PIN code to prevent unauthorized access to your system settings.

**Note:** We recommend you record the PIN code (password) and store it in a safe place if you use this feature.

When you establish password protection, the PIN code must be entered when any of the following are selected. After the correct PIN code is entered, all of them can be accessed without re-entering the PIN code.

- Settings, activated from the Tools panel or System Controls dialog
- Alarms, activated from the Tools panel
- Files, activated from the Tools panel
- GoFree Shop, activated from the Tools panel
- Settings, activated from the Chart menu under Chart Options

You set and remove password protection from the system Settings dialog.

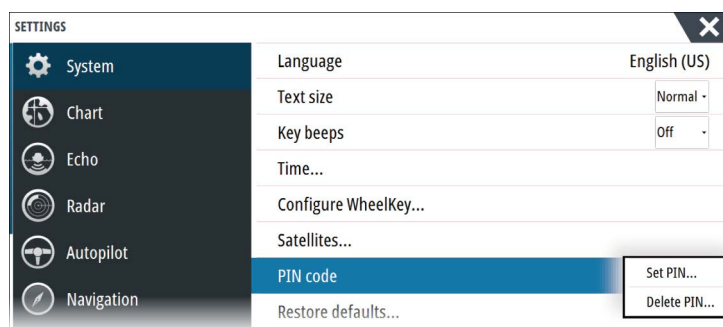

## Adding new favorite pages

1. Select the New icon in the favorite panel on the Home page to open the page editor dialog
2. Select the page icons you want to add to a new page:
  - Touch operation: drag and drop page icons
  - Key operation: use the arrow keys to select a page icon, then confirm your selection with the Enter key
3. (Optional) Change the panel arrangement (only possible when 2 or more panels)
4. Save the page layout.

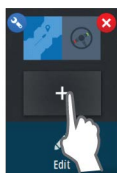

The system displays the new favorite page, and the new page is included in the list of favorite pages on the Home page.

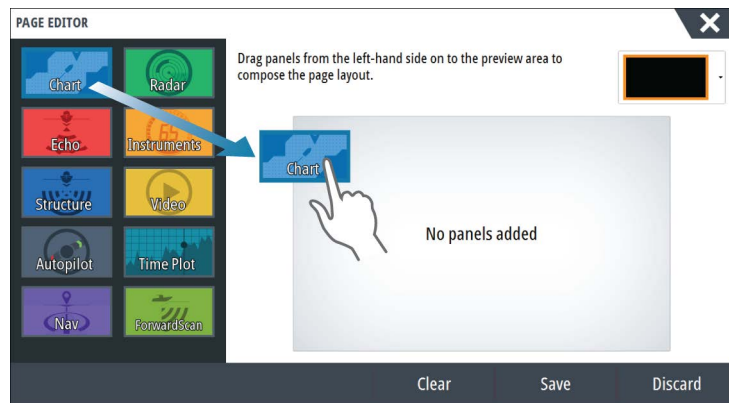

## Edit favorite pages

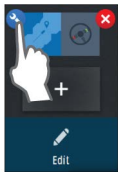

1. Select the edit icon in the Favorite panel:
  - Select the X icon on a favorite icon to remove the page
  - Select the tool icon on a favorite icon to display the page editor dialog
2. Add or remove panels in the page editor dialog
3. Save or discard your changes to leave the favorite edit mode.

## Setting the appearance of the Instrument bar

Data sources connected to the system can be viewed in the Instrument bar.

You can configure the Instrument bar to display either one or two bars. If you specify to display two bars you can set it to alternate the bars automatically. You can specify the information displayed in the instrument bars.

Use the menu to select a predefined activity for one or both of the bars. When an activity bar is selected, predefined instrument gauges are displayed in the instrument bar.

You can turn the Instrument bar off from the **System controls** dialog.

→ **Note:** This only turns the Instrument bar off for the current page.

### Turning the Instrument bar on/off

1. Activate the **System controls** dialog
2. Deactivate/activate the instrument bar icon to toggle the bar on and off.

### Select a predefined activity bar

1. Activate the Instrument bar by:
  - Touch operation: tapping the Instrument bar
  - Remote controller: pressing the WIN key until the Instrument bar is active
2. Select the **MENU** button to open the menu
3. Select **Bar 1** or **Bar 2** and then a predefined activity bar.

Predefined gauges are displayed in the instrument bar. You can change a gauge in the activity Instrument bar, refer to Edit the content of the Instrument bar below.

### Edit the content of the Instrument bar

1. Activate the Instrument bar by:
  - Touch operation: tapping the Instrument bar
  - Remote controller: pressing the **WIN** key until the Instrument bar is active
2. Select the **MENU** button to open the menu
3. Select **Edit** to change an instrument gauge followed by the gauge you want to change
4. Select the content you want to display from the Choose Data dialog
5. Select **Menu** and then **Finish editing** to save your changes.

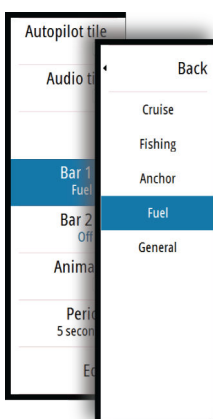

## Fuel economy gauge

You can display a fuel economy gauge in the instrument bar on application pages (Chart, Radar, Echo, Nav, and so on). Select the predefined Fuel activity bar or change a gauge source to Fuel Economy. To change a gauge source, refer to *"Setting the appearance of the Instrument bar"* on page 22.



- 1 Digital readout of current economy
- 2 Fuel economy measurement units
- 3 100% efficiency, this equates to the 'nominal consumption'
- 4 120% efficiency
- 5 Average fuel economy
- 6 Instantaneous economy
- 7 Current fuel level

The fuel economy gauge displays the instantaneous versus historical average fuel efficiency. The start of the green zone represents 'Nominal Fuel Economy', and it displays an additional 20% area to allow your fuel efficiency to be displayed above the nominal fuel economy.

The more efficient you consume fuel, the more the outer blue dial creeps up towards the green portion of the scale. If you achieve the nominal efficiency of your vessel you will be at the green zone. If you manage to achieve an efficiency better than your nominal efficiency, you will be somewhere in the upper green zone.

Nominal fuel economy can be entered in the Vessel Setup dialog displayed from the Fuel settings dialog.

You can reset your average fuel economy from the Reset Fuel Economy button on the Fuel settings dialog. When you reset it, the system starts calculating the new average.

Set the measurement units for the fuel economy gauge in the Economy field in the Units settings dialog.

## Bridge Control

The Bridge Control feature allows you to control which pages are shown on several displays at the same time. The feature is used on vessels with multiple displays mounted in the same place to quickly configure what information is displayed.

There can be a maximum of four different bridges on your system, and you can have up to four displays grouped into one bridge. Each display can be configured to only one bridge.

When the displays are included in a bridge, you can configure twelve page configurations (presets) for each bridge.

### Adding displays to a Bridge

→ **Note:** All displays must be turned on to be available for bridge configuration.

1. Open the **Bridge Configuration** dialog

2. Select to configure a new bridge or to edit an existing
  - The **Bridge Configuration** for the selected bridge will be shown, and all displays that are not already assigned to a bridge will be listed
3. Select the display you want to add to the bridge
  - Arrange the displays from left to right in the same physical layout as the displays on your current bridge/dashboard/helm
4. Rename the bridge if required
5. Save the configuration

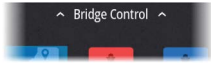

**Bridge Control** will be displayed on the **Home page** of all units that are configured for a bridge.

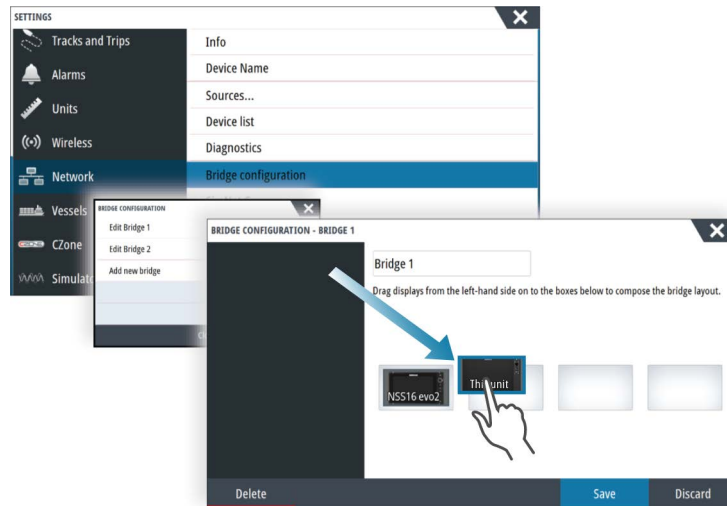

### Configuring the preset pages for displays in a bridge

1. Activate the Bridge Control panel by swiping down on **Bridge Control** on the **Home** page
2. To add a new bridge page, select the add icon. To edit an existing page, select the edit icon.
3. Select the display for which you want to define the preset page
  - The page layout option for the selected display will be read from the network, showing main features and configured favorite pages
4. Select the preferred page
  - Select the blank page if you do not want that display to be included in the selected **Bridge preset**
5. Repeat step 3 and 4 until a page is configured for all displays in all **Bridge presets**
6. Select the edit icon to leave the add or edit mode and to save your configuration

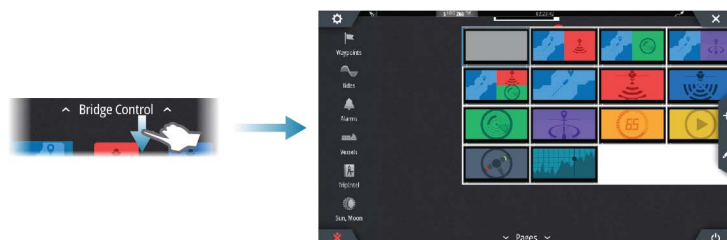

### Selecting Bridge presets

You display an overview of available **Bridge presets** by swiping down on **Bridge Control** on the **Home** page.

When you select one of the preset configurations all devices included in that bridge will switch to the pre-configured pages.

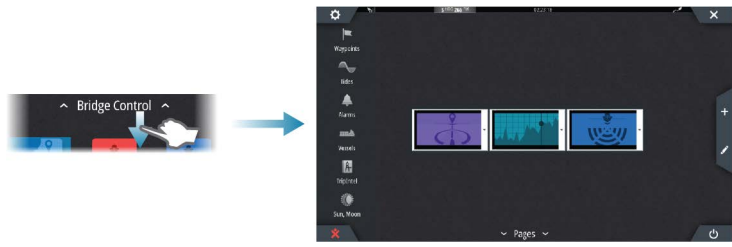

# 4

## Charts

The chart function displays your vessel's position relative to land and other chart objects. On the chart panel you can plan and navigate routes, place waypoints, and display AIS targets.

### The Chart panel

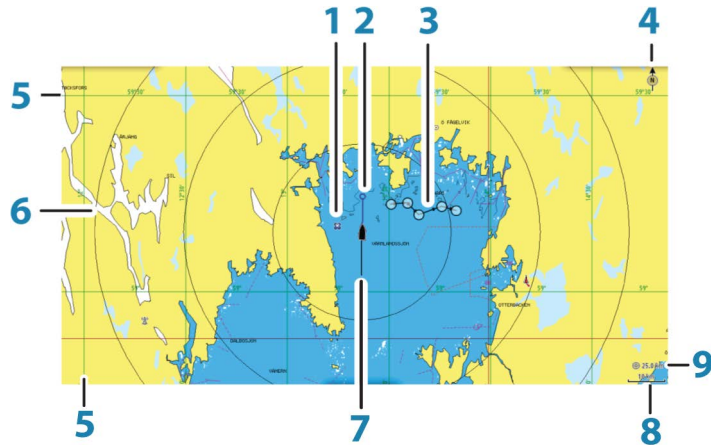

- 1 Waypoint\*
- 2 Vessel with extension line (extension line is optional)
- 3 Route\*
- 4 North indicator
- 5 Grid lines\*
- 6 Range rings\*
- 7 Track\*
- 8 Chart range scale
- 9 Range rings interval (only displayed when Range rings are turned on)

\* Optional chart items. You turn the optional chart items on/off individually from the Chart settings dialog.

### Chart data

The system is delivered with different preloaded cartography depending on region.

All units support Insight and C-MAP charts including C-MAP Genesis. The system also supports charts from Navionics as well as content created by a variety of third party mapping providers in the AT5 format. For a full selection of available charts, visit [www.gofreeshop.com](http://www.gofreeshop.com), [www.c-map.com](http://www.c-map.com), or [www.navionics.com](http://www.navionics.com).

→ **Note:** In this manual, all possible chart menu options are described. These options vary depending on the chart you are using.

Charts on chart cards are shared over the Ethernet network, so only one chart card per vessel is required.

→ **Note:** The system does not automatically switch to preloaded cartography if the chart card is removed. A low-resolution chart will be displayed until you re-insert the card or manually switch back to the preloaded cartography.

### Showing dual chart types

If you have different chart types available - preloaded, in the card slot, or on the Ethernet network - you can show two different chart types simultaneously on a page with two chart panels.

You can select a dual chart panel by pressing and holding the Chart application button on the **Home** page, or by creating a favorite page with two chart panels.

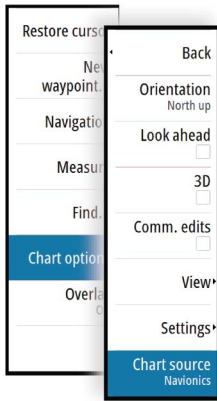

### Selecting chart type

You specify the chart type in the Chart panel by selecting one of the available chart types in the chart source menu option.

If you have a multiple Chart panel, the chart type is set individually for each chart panel. Activate one of the chart panels, and then select one of the available chart types in the chart source menu option. Repeat the process for the second chart panel, and select an alternative chart type for this panel.

If you have identical charts available - built in, in the card slot or on the Ethernet network - the system automatically selects the chart with most chart details for your displayed region.

### Panning the chart

You can move the chart in any direction by:

- Touch operation: dragging your finger on the screen
- Key operation: using the arrow keys to move the cursor to the edge of the chart panel in the desired direction.

Select the **Clear cursor** menu option or press the **X** key to remove the cursor and cursor window from the panel. This also centers the chart to the vessel position.

### Chart scale

You zoom in and out on the chart by using the zoom panel icons, the rotary knob, or by using 2 fingers to pinch (zoom out) and spread (zoom in).

Chart range scale and range rings interval (when turned on) are shown in the lower right corner of the chart panel.

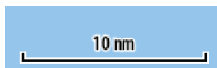

### Vessel symbol

When the system has a valid GPS position lock, the vessel symbol indicates vessel position. If no GPS position is available, the vessel symbol includes a question mark.

### Positioning the vessel on the chart panel

#### Chart orientation

You can specify how the chart is rotated in the panel. The chart orientation symbol in the panel's upper right corner indicates the north direction.

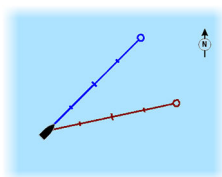

North up

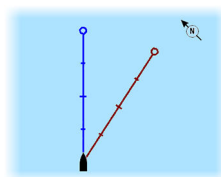

Heading up

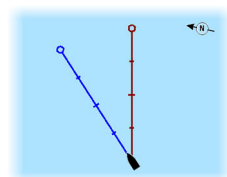

Course up

#### North up

Displays the chart with north upward.

#### Heading up

Displays the chart with the vessel's heading directed upward. Heading information is received from a compass. If heading is not available, then the COG from the GPS is used.

#### Course up

The chart direction is depending on if navigating or not:

- when navigating: the desired course line is oriented up

- if not navigating: the direction the vessel is actually traveling (COG) is oriented up

### Look ahead

Moves the vessel icon on the panel to maximize your view ahead of the vessel.

## Displaying information about chart items

When you select a chart item, a waypoint, a route, or a target, basic information for the selected item is displayed. Select the chart item's pop-up to display all available information for that item. You can also activate the detailed information dialog from the menu.

- **Note:** If you are viewing applicable C-MAP charts on your system, you can select marine objects to display information about services and available multimedia (photos) associated with the location or object.
- **Note:** Pop-up information has to be enabled in chart settings to see basic item information.

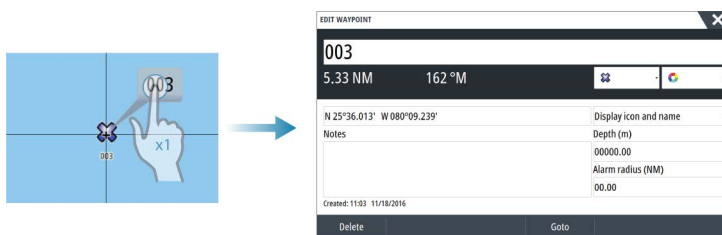

## Using the cursor on the chart panel

By default, the cursor is not shown on the chart panel.

When you activate the cursor, the cursor position window is displayed. When the cursor is active, the chart does not pan or rotate to follow the vessel.

N 59°01.280'  
E 13°37.148'  
110.5 mi, 104 °M

Select the **Clear cursor** menu option to remove the cursor and the cursor window from the panel. This also centers the chart to the vessel position.

Select the **Restore cursor** menu option to display the cursor in its previous location. The **Clear cursor** and **Restore cursor** options are useful features for toggling between the vessel's current location and the cursor position.

### GoTo cursor

You can navigate to a selected position on the image by positioning the cursor on the panel, then using the **Goto Cursor** option in the menu.

### The cursor assist function

- **Note:** The cursor assist function is available if it is enabled. Refer to "*Customizing the long press feature*" on page 20.

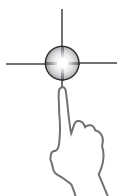

The cursor assist function allows for fine tuning and precision placement of the cursor without covering details with your finger.

Activate the cursor on the panel, then press and hold your finger on the screen to switch the cursor symbol to a selection circle, appearing above your finger.

Without removing your finger from the screen, drag the selection circle to the desired position.

When you remove your finger from the screen the cursor reverts to normal cursor operation.



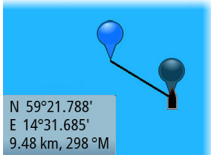

## Measuring distance

The cursor can be used to measure the distance between your vessel and a selected position, or between 2 points on the chart panel.

1. Position the cursor on the point from where you want to measure the distance. Start the measure function from the menu
  - The measuring icons appear with a line drawn from the vessel center to the cursor position, and the distance is listed in the cursor information window.
2. You can reposition the measuring points by dragging either icon as long as the measuring function is active

→ **Note:** The bearing is always measured from the grey icon to the blue icon.

You can also start the measuring function without an active cursor. Both measuring icons are then initially located at the vessel position. The grey icon follows the vessel as the vessel moves, while the blue icon remains at the position given when you activated the function. You terminate the measuring function by selecting the **Finish measuring** menu option.

## Saving waypoints

Use the new waypoint menu option to save a waypoint on the panel. If the cursor is active, the waypoint is saved at the cursor position. If the cursor is not active, the waypoint is saved at your vessel's position.

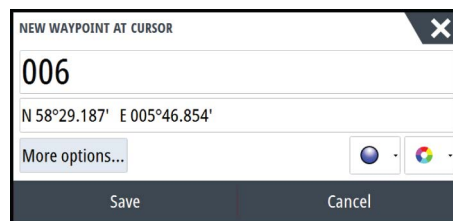

## Creating routes

You can create routes as follows on the chart panel.

1. Position the cursor on the chart panel
2. Select **New** followed by **New route** in the menu
3. Select the position for the first routepoint:
  - On touch screen: tap the chart panel
  - Key operation: use the arrow key to select position, then confirm by pressing the **Enter** key
4. Continue positioning the remaining routepoints
5. Save the route by selecting the save option in the menu.

→ **Note:** For more information, refer to "*Waypoints, Routes, and Tracks*" on page 41.

## Find objects on chart panels

You can search for other vessels or various chart items from a chart panel.

Activate the cursor on the panel to search from the cursor position. If the cursor is not active, the system searches for items from the vessel's position.

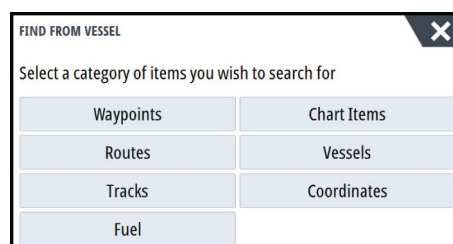

→ **Note:** You must have a SIRIUS data package subscription to search for fueling stations and an AIS receiver connected to search for vessels.

## Marine Search and Rescue (SAR) feature

The marine SAR feature creates a search pattern route in the form of a parallel or creeping line search pattern on the chart.

Turn the SAR feature ON from the Advanced, Features option in the System Settings dialog.

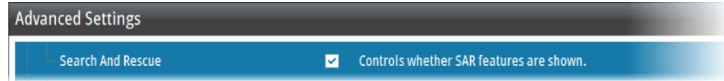

The following is an example of a SAR area on the chart.

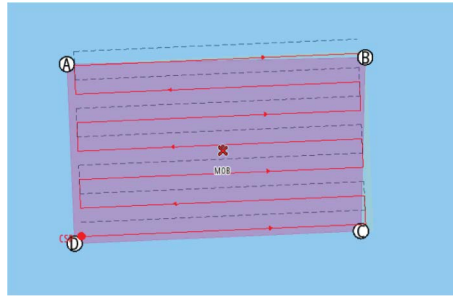

The purple area is the area that is defined by you. The light orange shading is the area that is calculated by the system.

### Setting up the search area

Place the cursor on the chart in the location of Point A. Then use the New search pattern menu option to set up the search area. This option opens the SAR Edit dialog.

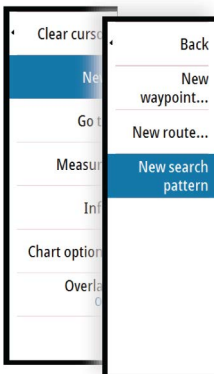

Point A	N 58°29.247' E 6°14.707'
Point B	N 58°29.246' E 6°18.534'
Point C	N 58°27.246' E 6°18.534'
Point D	N 58°27.245' E 6°14.711'
Starting corner (CSP)	D
Direction	Parallel
Track width (m)	300
Number of vessels	1
<span>Close</span> <span>Start Search</span>	

Define the four corners of the search area, by entering corner coordinates.

The following settings must be defined:

- **Track width** controls how much space is in between parallel legs (the legs with the longest length).
- **Number of vessels** controls how many SAR routes are generated. An SAR route is created for each vessel. The first vessel will have a red route and the others will have a dashed black route. The space between each vessel is the track spacing distance.
- **Direction** can be either Parallel or Creeping. Parallel direction makes the route move along the side with the longest length. Creeping is the opposite as it moves along the shortest side.
- **Starting corner (CSP)** is determined by choosing which corner you want to start from.

The system will calculate the number of legs and leg distances. It also calculates the Commence Start Position (CSP) as half the track spacing from the starting corner. The start heading is calculated as the heading parallel to the longest side of the search rectangle from the start position.

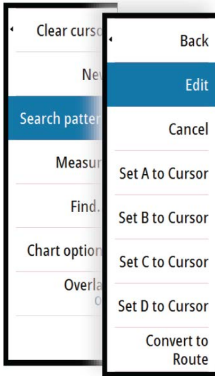

### Editing the search parameters

Use the Edit SAR dialog to alter search pattern parameters.

You can also change the 4 corners of the search area using the set to cursor menu options. Position the cursor on the chart and then select the appropriate set to cursor menu option.

→ **Note:** The Close option on the Edit SAR dialog saves changes and closes the dialog. It does not terminate the SAR.

### Detect participating vessels not on the search pattern

Turn on AIS targets and Radar overlay to see participating vessels that are not on their search pattern. Once identified, you can direct them back to the track.

### Terminating the SAR session

Use the Cancel Search pattern menu option to stop the search.

### Convert a SAR to a route

The Convert to route option allows you to name, edit, and save it to your route library.

## 3D charts

The 3D option provides a three dimensional graphical view of land and sea contours.

→ **Note:** All chart types work in 3D mode, but without 3D cartography for the appropriate area the chart appears flat.

When the 3D chart option is selected, the Pan and the Rotate icons appear on the chart panel.



### Panning the 3D chart

You can move the chart in any direction by selecting the Pan icon and then panning in the desired direction.

### Controlling the view angle

You can control the view angle by selecting the Rotate icon and then panning the chart panel.

- To change the direction you are viewing, pan horizontally
- To change the tilt angle of the view, pan vertically

→ **Note:** When centered on the vessel position, only the tilt angle can be adjusted. The view direction is controlled by the chart orientation setting. See "*Positioning the vessel on the chart panel*" on page 27.

### Zooming a 3D chart

You zoom in and out on a 3D chart by using the zoom panel icons, or by:

- Remote controller: using the **IN** and **OUT** keys
- Keyboard: using the **+** and **-** keys

## Chart overlay

Radar, Structure, Heat map, SonarChart Live (Navionics charts only) and weather data can be displayed as overlay on your chart panel.

When an overlay is selected, the chart menu expands to include basic menu functions for the selected overlay.

Information about the overlay data are described in more detail in separate sections in this manual.

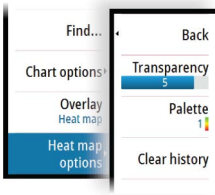

## Heat map overlay

The Heat map overlay feature shows a history of water temperature coloring on the chart. A water temperature source is needed to provide the temperature data for the overlay (e.g. an Echosounder transducer, a NMEA 2000 water temperature sensor, etc.).

The color range is adjusted automatically based on the minimum and maximum temperatures recorded.

Select the color palette you want the system to use to show water temperatures. A legend is shown on the panel that identifies the colors associated with the recorded temperatures.

Use the transparency option to set the transparency of the overlay on the chart.

Use the clear history option to delete all heat map data gathered up to the moment it is selected. Heat map data is automatically deleted when the unit is turned off.

## Insight and C-MAP charts

All possible menu options for Insight and C-MAP charts are described below. The features and menu options available can vary depending on the charts you use. This section shows menus from an Insight chart.

→ **Note:** A menu option is greyed out if it is not available on the chart displayed. For example, raster charts are not available with Insight, so the Raster charts menu option is greyed out when Insight charts are displayed.

## Insight and C-MAP tides and currents

The system can display Insight and C-MAP tides and currents. With this information it is possible to predict the time, level, direction and strength of currents and tides. This is an important tool when considering planning and navigation of a trip.

In large zoom ranges the tides and currents are displayed as a square icon including the letter **T** (Tides) or **C** (Current). When you select one of the icons, tidal or current information for that location are displayed.

Dynamic current data can be viewed by zooming inside a 1-nautical mile zoom range. At that range, the Current icon changes to an animated dynamic icon that shows the speed and direction of the current. Dynamic icons are colored in black (greater than 6 knots), red (greater than 2 knots and less than or equal to 6 knots), yellow (greater than 1 knot and less than or equal to 2 knots) or green (equal to or less than 1 knot), depending on the current in that location.

If there is no current (0 knots) this will be shown as a white, square icon.

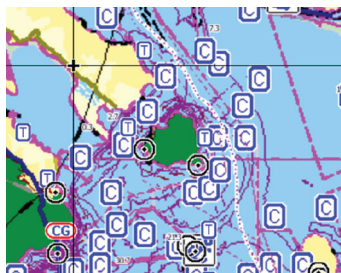

*Static Current and Tide icons*

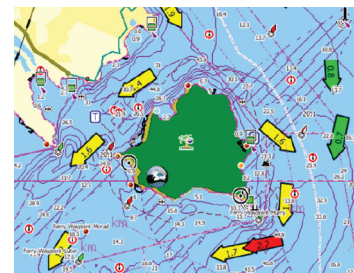

*Dynamic Current icons*

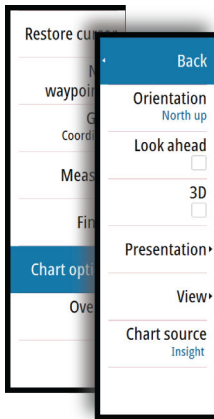

## Insight and C-MAP specific chart options

Orientation, Look ahead, 3D, and change Chart source (previously described in this section) are common for all chart types.

### Presentation

The charts can be displayed in different imagery styles.



*Shaded relief*

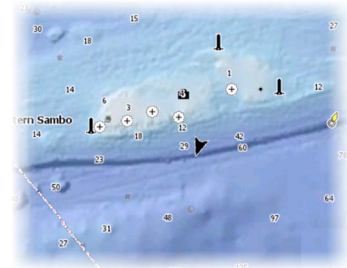

*No contours*

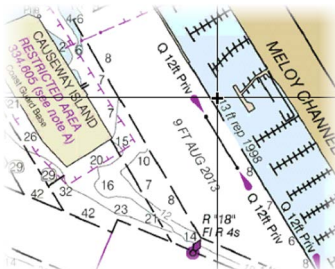

*Raster imagery*

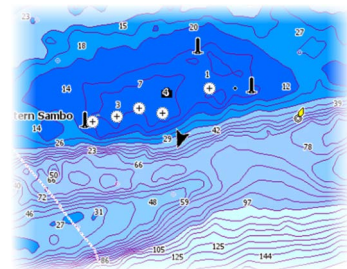

*High resolution bathymetry*

#### Shaded relief

Shades seabed terrain.

#### No contours

Removes contour lines from the chart.

#### Raster charts

Changes the view to that of a traditional paper chart.

#### Raster transparency

Controls the transparency of raster imagery.

#### High resolution bathymetry

Enables and disables higher concentration of contour lines.

#### Genesis Layer

The Genesis Layer displays high-resolution contours contributed by Genesis users that have passed a quality check.

This option toggles the Genesis layer on/off on the chart image.

Available only if the C-MAP chart contains Genesis Layer data.

## Insight and C-MAP view options

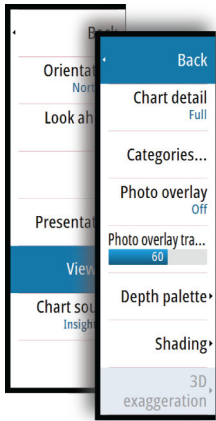

### Chart detail

- **Full**  
All available information for the chart in use.
- **Medium**  
Minimum information sufficient for navigation.
- **Low**  
Basic level of information that cannot be removed, and includes information that is required in all geographic areas. It is not intended to be sufficient for safe navigation.

### Insight and C-MAP chart categories

Insight and C-MAP charts include several categories and sub-categories that you can turn on/off individually depending on which information you want to see.

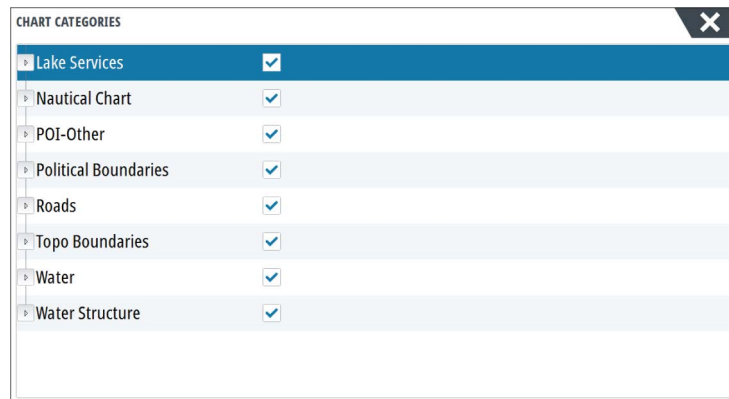

### Photo overlay

Photo overlay enables you to view satellite photo images of an area as an overlay on the chart. The availability of such photos is limited to certain regions, and cartography versions. You can view photo overlays in either 2D or 3D modes.



*No Photo overlay*



*Photo overlay, land only*



*Full Photo overlay*

### Photo transparency

The Photo transparency sets the opaqueness of the photo overlay. With minimum transparency settings the chart details are almost hidden by the photo.



*Minimum transparency*



*Transparency at 80*



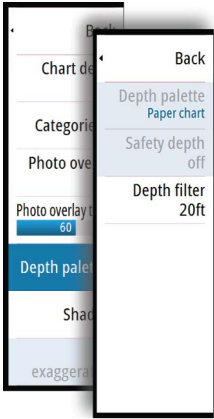

### Depth palette

Controls the Depth palette used on the map.

### Paper chart

Changes the appearance of the map to a paper chart style.

### Safety depth

Insight and C-MAP charts use different shades of blue to distinguish between shallow (lighter shades) and deep (darker shades) water. After enabling Safety depth, specify the desired safety depth limit. The Safety depth sets the limit at which depths will be drawn without blue shading.

### Depth filter

Filters out depth values shallower than the selected depth filter limit.

### Shading

Shades different areas of the seabed, depending on the selected Shading category.

→ **Note:** Composition and Vegetation shading are not applicable to C-MAP charts.

### Depth 1 and Depth 2

Depth presets that shade different depths in different colors.

### Custom

You can adjust the depth threshold, color and opacity (transparency) of color shading for Depth 1 and Depth 2.

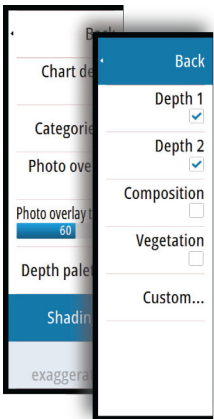

CUSTOM SHADING			
	Depth 1	Depth 2	Vegetation
Depth (ft)	Color		Opacity (%)
0			100
40			100
80			100
120			100
160			100
Add Point...			

### 3D exaggeration

Graphical settings that are available in 3D mode only. Exaggeration is a multiplier applied to the drawn height of hills on land, and troughs in water to make them look taller or deeper.

→ **Note:** This option is grayed out if the data is not available in the map card inserted.

## Navionics charts

Some Navionics features require the most current data from Navionics. For those features, a message is displayed stating that the feature is unavailable if you do not have the appropriate Navionics charts or chart card inserted. For more information on what is required for these features, refer to [www.navionics.com](http://www.navionics.com).

You can also get a message if you try to use a restricted feature when the Navionics chart card is not activated. To activate the card, contact Navionics.

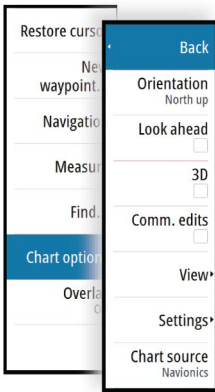

### Navionics specific chart options

Orientation, Look ahead, 3D and change Chart source (previously described in this section) are common for all chart types.

#### Community edits

Toggles on the chart layer including Navionics edits. These are user information or edits uploaded to Navionics Community by users, and made available in Navionics charts.

For more information, refer to Navionics information included with your chart, or to Navionics website: [www.navionics.com](http://www.navionics.com).

#### SonarChart Live

SonarChart Live is a real-time feature where the device creates an overlay of depth contours based on your own live sonar soundings.

In the Navionics chart menu, select **Overlay** and then **SonarChart Live** to display it as an overlay on the chart.

When you select SonarChart Live overlay the menu expands to display SonarChart Live Options. Use the options to set the transparency and minimum depth.

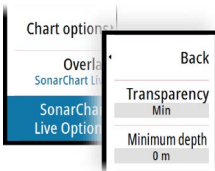

#### Transparency

The SonarChart Live overlay is drawn on top of other chart data. The chart data is completely covered at minimum transparency. Adjust the transparency to allow the chart details to be seen.

#### Minimum depth

Adjusts what SonarChart Live rendering treats as the safety depth. This affects the coloring of the SonarChart Live area. As the vessel approaches the safety depth, the SonarChart Live area will gradually change from a simple grey/white to red.

#### SCL History

→ **Note:** If no active Navionics chart subscription is found, the SonarChart Live menu option changes to SCL History.

Select to display previously recorded data on the chart overlay.

### Navionics view options

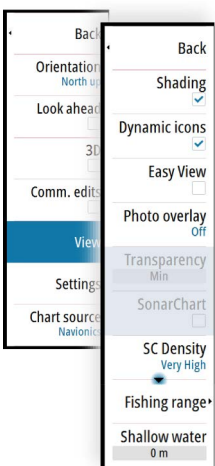

#### Chart shading

Shading adds terrain information to the chart.

#### Navionics dynamic tide and current icons

Shows tides and currents with a gauge and an arrow instead of the diamond icons used for static tides and current information.

The tide and current data available in Navionics charts are related to a specific date and time. The system animates the arrows and/or gauges to show the tides and currents evolution over time.

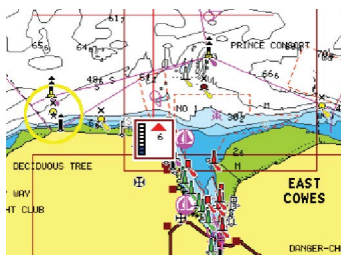

Dynamic tide information

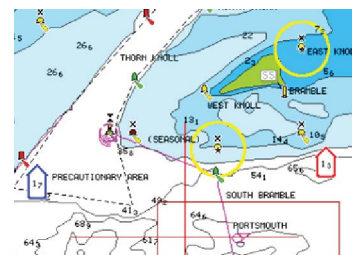

Dynamic current information

The following icons and symbology are used:





### Current speed

The arrow length depends on the rate, and the symbol is rotated according to flow direction. Flow rate is shown inside the arrow symbol. The red symbol is used when current speed is increasing, and the blue symbol is used when current speed is decreasing.



### Tide height

The gauge has 8 labels and is set according to absolute max/min value of the evaluated day. The red arrow is used when tide is rising, and the blue arrow is used when tide is falling.

→ **Note:** All numeric values are shown in the relevant system units (unit of measurement) set by user.

### Easy View

Magnifying feature that increases the size of chart items and text.

→ **Note:** There is no indication on the chart showing that this feature is active.

### Photo overlay

Photo overlay enables you to view satellite photo images of an area as an overlay on the chart. The availability of such photos is limited to certain regions, and cartography versions. You can view photo overlays in either 2D or 3D modes.



No Photo overlay



Photo overlay, land only



Full Photo overlay

### Photo transparency

The Photo transparency sets the opaqueness of the photo overlay. With minimum transparency settings the chart details are almost hidden by the photo.



Minimum transparency

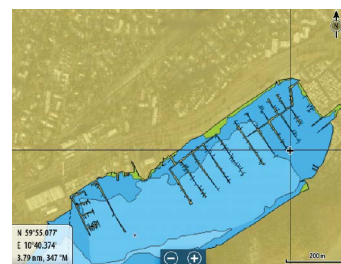

Maximum transparency

### SonarChart

The system supports the Navionics SonarChart feature.

SonarChart displays a bathymetry map showing high resolution contour detail and standard navigational data. For more information, refer to [www.navionics.com](http://www.navionics.com).

### SC Density

Controls the density of the SonarChart and SonarChart Live contours.

### Fishing range

Select a range of depths between which Navionics fills with a different color.

This allows you to highlight a specific range of depths for fishing purposes. The range is only as accurate as the underlying chart data, meaning that if the chart only contains 5 meter intervals for contour lines, the shading is rounded to the nearest available contour line.

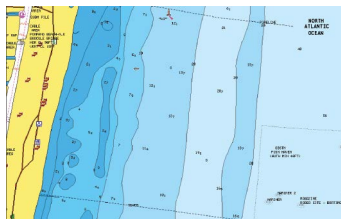

*No Depth highlight range*

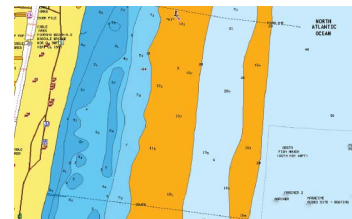

*Depth highlight range: 6 m - 12 m*

### Shallow water highlight

Highlights areas of shallow water.

This allows you to highlight areas of water between 0 and the selected depth (up to 10 meters/30 feet).

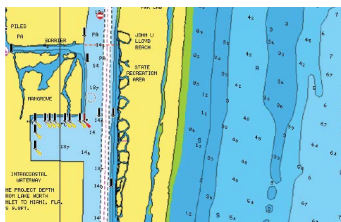

*No shallow water highlighted*

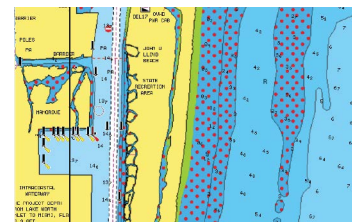

*Shallow water highlight: 0 m - 3 m*

## Navionics chart settings

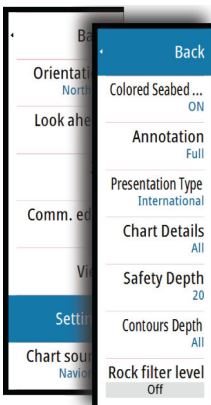

### Colored seabed areas

Used for displaying different depth areas in different shades of blue.

### Presentation type

Provides marine charting information such as symbols, colors of the navigation chart and wording for either International or U.S. presentation types.

### Annotation

Determines what area information, such as names of locations and notes of areas, is available to display.

### Chart details

Provides you with different levels of geographical layer information.

### Safety depth

The Navionics charts use different shades of blue to distinguish between shallow and deep water.

Safety depth, based on a selected limit, is drawn without blue shading.

→ **Note:** The built in Navionics database features data down to 20 m, after which it is all white.

### Contours depth

Determines which contours you see on the chart down to the selected safety depth value.

### Rock filter level

Hides rock identification on the chart beneath a given depth.

This helps you to declutter charts in areas where there are many rocks located at depths well below your vessel's draught.

## Chart settings

Settings and display options made in the Chart settings page are common for all chart panels.

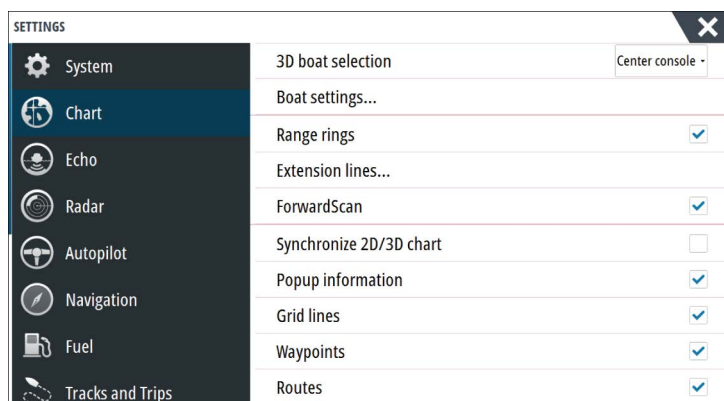

### 3D boat selection

Determines which icon to use on 3D charts.

### Boat settings

The boat settings are used when calculating an automatic route. The boat's draught, width and height must be input to use Navionics Dock-to-dock autorouting and easy routing features.

→ **Note:** Dock-to-dock Autorouting is not available in units used in U.S. territorial waters.

### Range Rings

The range rings can be used to present the distance from your vessel to other chart objects. The range scale is set automatically by the system to suit the chart scale.

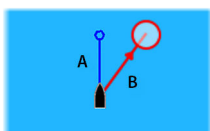

### Extension lines

Sets the lengths of the extension lines for your vessel and for other vessels shown as AIS targets.

**A:** Heading

**B:** Course Over Ground (COG)

The lengths of the extension lines are either set as a fixed distance, or to indicate the distance the vessel moves in the selected time period. If no options are turned on for the vessel then no extension lines are shown for your vessel.

Your vessel heading is based on information from the active heading sensor and the COG is based on information from the active GPS sensor.

For other vessels, COG data is included in the message received from the AIS system.

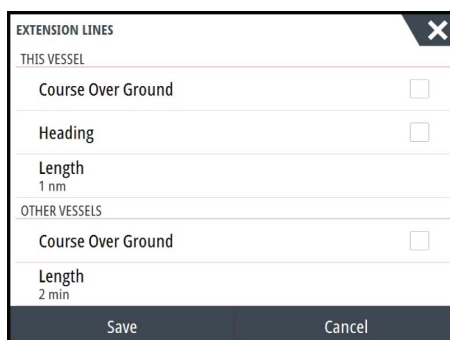

**ForwardScan**

If you have ForwardScan and this option is selected, the ForwardScan heading extension is shown on the chart. Refer to "*Heading extension*" on page 98.

**SonarChart Live tide correction**

When selected, the tide correction feature uses information from nearby tide stations (if available) to adjust the depth values used by SonarChart Live as the sonar is recorded.

**Synchronize 2D/3D chart**

Links the position shown on one chart with the position shown on the other chart when a 2D and a 3D chart are shown side by side.

**Pop-up information**

Selects whether basic information for chart items is displayed when you select the item.

**Grid lines**

Turns on/off viewing of longitude and latitude grid lines on the chart.

**Waypoints, Routes, Tracks**

Turns on/off displaying of these items on chart panels. Also opens the Waypoints, Routes and Tracks dialogs you can use to manage them.

# 5

## Waypoints, Routes, and Tracks

### Waypoints

A waypoint is a user generated mark positioned on a chart, on a radar image or on the Echosounder image. Each waypoint has an exact position with latitude and longitude coordinates. A waypoint positioned on the Echosounder image has a depth value, in addition to position information. A waypoint is used to mark a position you later may want to return to. Two or more waypoints can also be combined to create a route.

### Saving waypoints

Use the new waypoint menu option to save a waypoint on the panel. If the cursor is active, the waypoint is saved at the cursor position. If the cursor is not active, the waypoint is saved at your vessel's position.

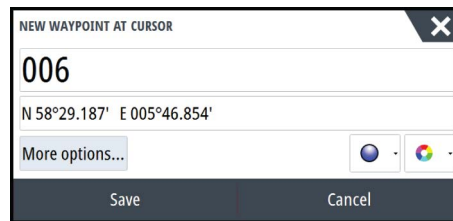

### Moving a waypoint

1. Select the waypoint you want to move. The waypoint icon expands to indicate that it is active.
2. Activate the menu and select the waypoint in the menu
3. Select the move option
4. Select the new waypoint position
5. Press the **Enter** key or the rotary knob to confirm the new position.

The waypoint is now automatically saved at the new position.



### Edit a waypoint

You can edit all information about a waypoint from the **Edit Waypoint** dialog.

This dialog is activated by selecting the waypoint's pop-up, or from the menu when the waypoint is activated.

The dialog can also be accessed from the Waypoints tool on the **Home** page.

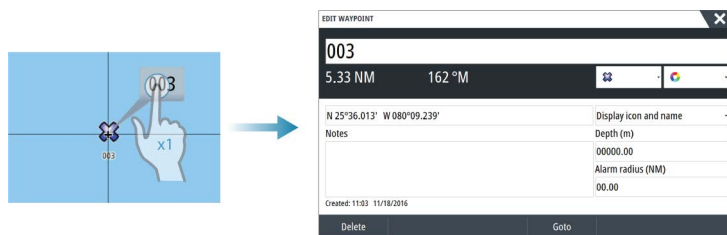

### Delete a waypoint

You can delete a waypoint from the **Edit Waypoint** dialog or by selecting the **Delete** menu option when the waypoint is activated.

You can also delete waypoints from the Waypoints tool on the **Home** page.

You can delete MOB waypoints the same way.

### Waypoint alarm settings

You can set an alarm radius for each individual waypoint you create. The alarm is set in the **Edit Waypoint** dialog.

- **Note:** The waypoint radius alarm must be toggled ON in the alarm dialog to activate an alarm when your vessel comes within the defined radius. For more information, refer to "*Alarms dialog*" on page 126.

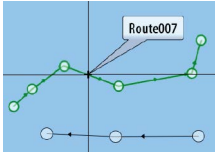

## Routes

A route consists of a series of routepoints entered in the order that you want to navigate them.

When you select a route on the chart panel it turns green, and the route name is displayed.

The system includes support for Navionics Autorouting and C-MAP Easy Routing. This feature automatically suggests routepoints between the first and last routepoint of a route, or between selected routepoints in a complex route. You can use the feature when you create a new route, or you can use it to edit already saved routes.

### Creating a new route on the chart panel

1. Activate the cursor on the chart panel
2. Select the new route option from the menu
3. Position the first waypoint on the chart panel
4. Continue positioning new routepoints on the chart panel until the route is completed
5. Save the route by selecting the save option in the menu.

### Edit a route from the chart panel

1. Select the route to make it active
  2. Select the route edit option in the menu
  3. Position the new routepoint on the chart panel:
    - If you set the new routepoint on a leg, a new point is added between existing routepoints
    - If you set the new routepoint outside the route, the new routepoint is added after the last point in the route
  4. Drag a routepoint to move it to a new position
  5. Save the route by selecting the save option in the menu.
- **Note:** The menu changes depending on the selected edit option. All edits are confirmed or cancelled from the menu.

### Delete a route

You can delete a route by selecting the **Delete** menu option when the route is activated.

You can also delete routes from the Routes dialog. Refer to "*Waypoints, Routes, and dialogs*" on page 46.

### Dock-to-dock Autorouting and Easy Routing

The Dock-to-dock Autorouting and Easy Routing suggest new routepoint positions based on information in the map and on your boat's size. Before you can start using this feature the boat draught, width and height must be entered into the system. The boat settings dialog is automatically displayed if the information is missing when you start the feature.

- **Note:** Units designed for sale in the U.S. region do not have Autorouting capabilities. Autorouting features are disabled on all non-U.S. units when they are used in U.S. territorial waters.
- **Note:** It is not possible to start the Dock-to-dock Autorouting or Easy Routing if one of the selected routepoints is located in an unsafe area. A warning dialog is displayed, and you have to move the relevant routepoint(s) to a safe area to proceed.
- **Note:** If no compatible cartography is available, the Dock-to-dock Autorouting or Easy Routing menu option is not available. Compatible cartography includes C-MAP MAX-N+, Navionics+ and Navionics Platinum. For a full selection of available charts, visit [www.gofreemarine.com](http://www.gofreemarine.com), [www.c-map.com](http://www.c-map.com) or [www.navionics.com](http://www.navionics.com).
1. Position at least two routepoints on a new route, or open an existing route for editing.
  2. Select **Dock-to-dock Autorouting**, followed by:

- **Entire Route** if you want the system to add new routepoints between the first and the last routepoint of the open route.
  - **Selection** if you want to manually select the routepoints that define the limits for the autorouting, then select the relevant routepoints. Selected routepoints are colored red. Only two routepoints can be selected, and the system discards any routepoints between your selected start and end points.
3. Select **Accept** to start the automatic routing.
    - When the automatic routing is completed the route appears in preview mode, and the legs are color coded to indicate safe or unsafe areas. Navionics uses red (unsafe) and green (safe), while C-MAP uses red (unsafe), yellow (dangerous) and green (safe).
  4. Move any routepoints if required when the route is in preview mode.
  5. Select **Keep** to accept the routepoints positions.
  6. Eventually repeat step 2 (**Selection**) and step 3 if you want the system to automatically position routepoints for other parts of the route.
  7. Select **Save** to complete the automatic routing and save the route.

#### Dock-to-dock Autorouting and Easy Routing examples

- **Entire route** option used when first and last route points are selected.



First and last routepoint



Result after automatic routing

- **Selection** option used for autorouting part of a route.



Two routepoints selected



Result after automatic routing

#### Creating routes using existing waypoints

You can create a new route by combining existing waypoints from the **Routes** dialog. The dialog is activated by using the **Waypoints** tool on the **Home** page and then selecting the **Routes** tab.

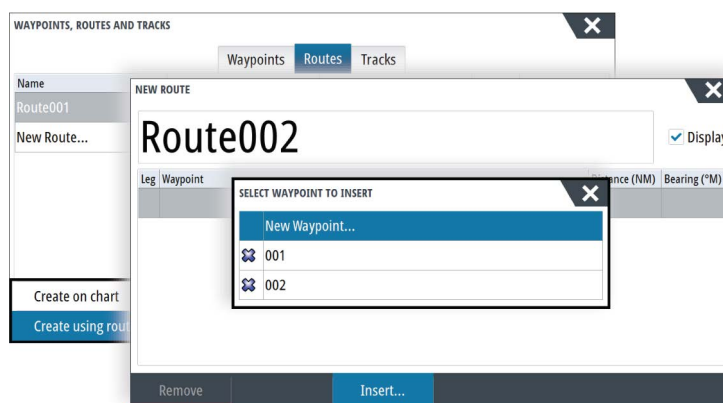

## Converting Tracks to Routes

You can convert a track to a route from the Edit Track dialog. The dialog is activated by activating the track, then selecting the track's pop-up, or by selecting the track from the menu.

The Edit Track dialog can also be accessed by selecting the **Waypoints** tool on the **Home** page.

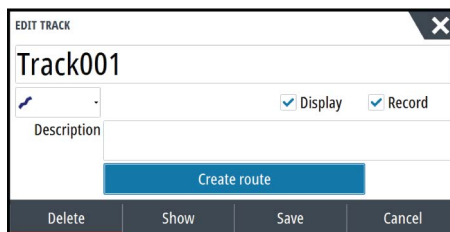

## The Edit Route dialog

You can add and remove routepoints, and change route properties using the **Edit Route** dialog. This dialog is activated by selecting an active route's pop-up or from the menu by selecting the route then the details option.

The dialog can also be accessed by using the **Waypoints** tool on the **Home** page.

Select **Display** to show the route on the chart.

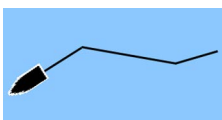
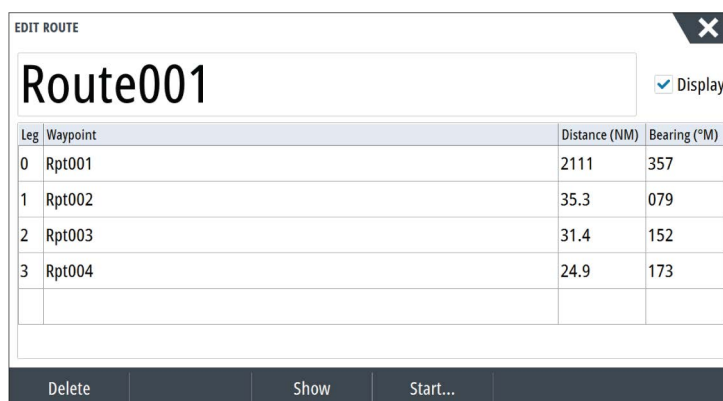

## Tracks

Tracks are a graphical presentation of the historical path of the vessel, allowing you to retrace where you have travelled. Tracks can be converted to routes from the **Edit** dialog.

From the factory, the system is set to automatically track and draw the vessel's movement on the chart panel. The system continues to record the Tracks until the length reaches the maximum points, and then automatically begins overwriting the oldest points.

The automatic tracking function can be turned off from the Tracks dialog.

## Creating new Tracks

You can start a new track from the **Tracks** dialog, activated by using the **Waypoints** tool on the **Home** page.

## Tracks settings

Tracks are made up of a series of points connected by line segments whose length depends on the frequency of the recording.

You can select to position track points based on time settings, distance, or by letting the system position a waypoint automatically when a course change is registered.

→ **Note:** The Tracks option must also be turned ON in the panel settings dialog to be visible.



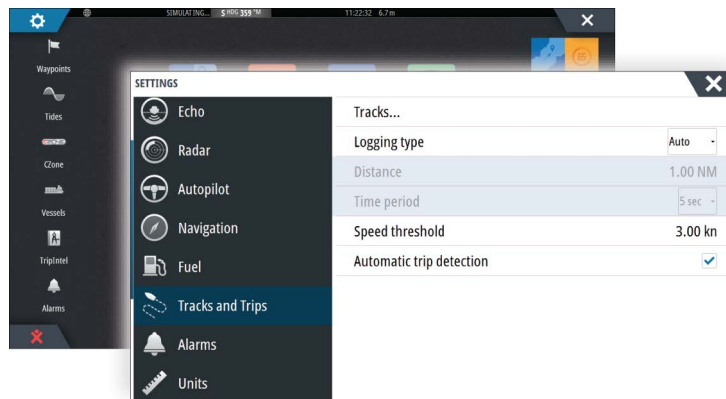

The track can be colored two ways:

- Select the track in the Tracks dialog and set the color for the entire track in the Edit Track dialog.
- Select to let the system color the track based on source data and high/low settings. Refer to *"Color tracks based on data"* on page 45.

#### Color tracks based on data

A track can be colored based on what source data and the high/low limits you set:

- Select the color tracks menu option and then the source option to specify the source (data type) to be colored. To turn off coloring, select source **None**.

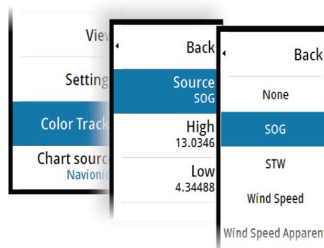

- Select the high and low options to set high and low values (after you specify the source).

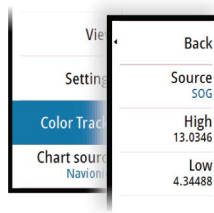

A colored track represents only one data source at a time. If you switch from one source to another, then the colors represent the newly selected source.

The colors can be shades of green, yellow, and red. Green is for the high limit you set. Yellow is the value that is the average of the high and low. Red is for the low limit. If the value is between the high and the middle values, it appears as a greenish-yellow color. If the value is between the middle and the low, it appears as an orange color.

→ **Note:** By default tracks are colored according to the color setting in the Edit Track dialog. Coloring tracks based on source data overrides the coloring specified in the Edit Track dialog.

If two or more charts are displayed in a split panel, changing the color source or high/low values on one chart does not change the other charts.

### Displaying source data in the cursor window

Selecting a point in a trail displays the cursor position window. If recorded source data exists for the point selected, the value is shown in the window in addition to the other cursor information.

The system records data according to your settings in the edit Trail dialog. Source data points are recorded when there is a change in the course or heading.

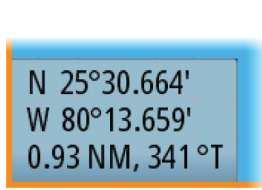

Cursor position window showing no SOG value



Cursor position window showing SOG value

## Waypoints, Routes, and Tracks dialogs

The Waypoints, Routes, and Tracks dialogs give access to advanced edit functions and settings for these items.

The dialogs are accessed by selecting the **Waypoints** button on the **Tools panel** on the **Home** page.

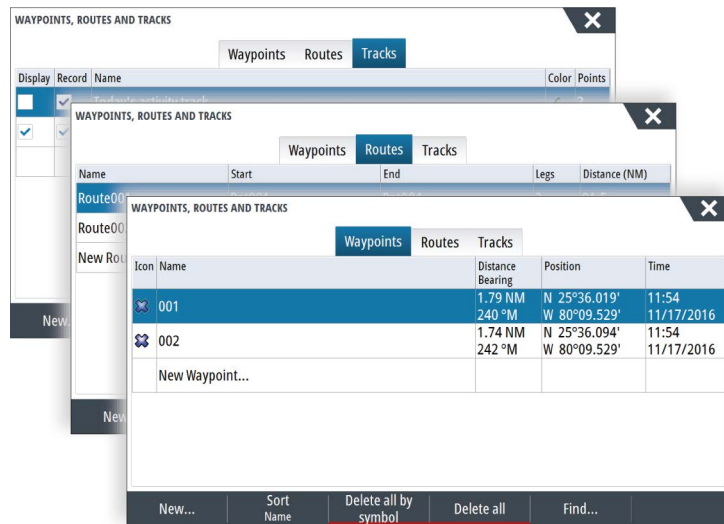

# 6

## Navigating

The navigation function included in the system allows you to navigate to the cursor position, to a waypoint, or along a predefined route.

If autopilot functionality is included in your system, the autopilot can be set to automatically navigate the vessel.

For information about positioning waypoints and creating routes, refer to "*Waypoints, Routes, and Tracks*" on page 41.

### Navigation panels

The Nav and Position panels can be used to display information when you are navigating.

#### The Nav panel

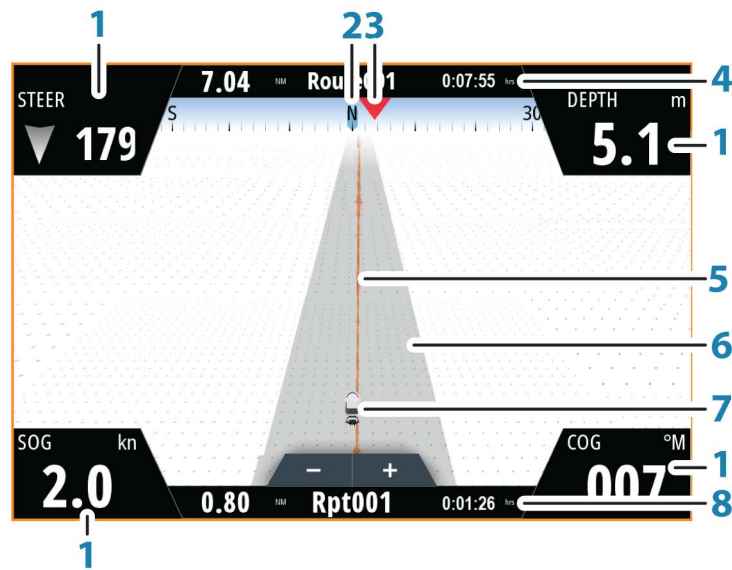

The Nav panel is activated from the Home page, either as a full page panel or as part of a multiple panel page.

- 1 Data fields**
- 2 Vessel heading**
- 3 Bearing to next routepoint**
- 4 Route information**

Indicates the distance of the route, the route name, and the estimated time to reach the end of the route
- 5 Bearing line**

When travelling on a route the bearing line shows the intended course from one waypoint towards the next. When navigating towards a waypoint (cursor position, MOB or an entered lat/lon position), the bearing line shows the intended course from the point at which navigation was started towards the waypoint.
- 6 XTE limit**

Indicates the XTE limit boundaries. If the XTE (Cross Track Error) exceeds the defined XTE limit, this is indicated with a red arrow including the distance from the track line. Refer to "*XTE limit*" on page 50.
- 7 Vessel symbol**

Indicates boat position and heading.
- 8 Routepoint information**

Indicates the distance to the routepoint, the routepoint name, and the estimated time to reach the routepoint.

## Position panels

You can switch between displaying the Nav panel or the Position panel. The Position panel is activated from the menu.

By default, there is one position panel available showing GPS position.

If Loran is enabled, there are two position panels. This is indicated with arrow symbols on left and right side of the panel.

You toggle between the panels by selecting the left or right arrow symbols, or by using the arrow keys.

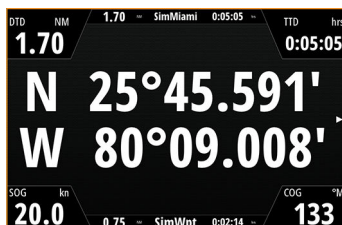

GPS position info



Loran position info

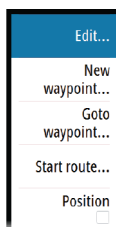

## Edit data fields

To change the data fields displayed on the Navigation panels:

1. Activate the menu
2. Select the edit option from the menu
3. Activate the field you want to edit
4. Select the information type
5. Save your changes.

## Navigate to cursor position

You can start navigating to a cursor position on any chart, radar, or Echosounder panel.

Position the cursor at the selected destination on the panel, and then select the **Goto Cursor** option in the menu.

→ **Note:** The **Goto Cursor** menu option is not available if you are already navigating.

## Navigate a route

You can start navigating a route from the chart panel or from the **Route** dialog.

When route navigation is started, the menu expands and shows options for canceling the navigation, for skipping a waypoint, and for restarting the route from current vessel position.

## Starting a route from the chart panel

Activate a route on the panel, and then select the route navigation option from the menu.

You can select a routepoint to start navigating from a selected position.

## Start navigating a route from the Route dialog

You can start navigating from the **Route** dialog, activated by:

- Selecting the **Waypoint** tool from the **Home** page and then the **Routes** tab
- Selecting the route details from the menu

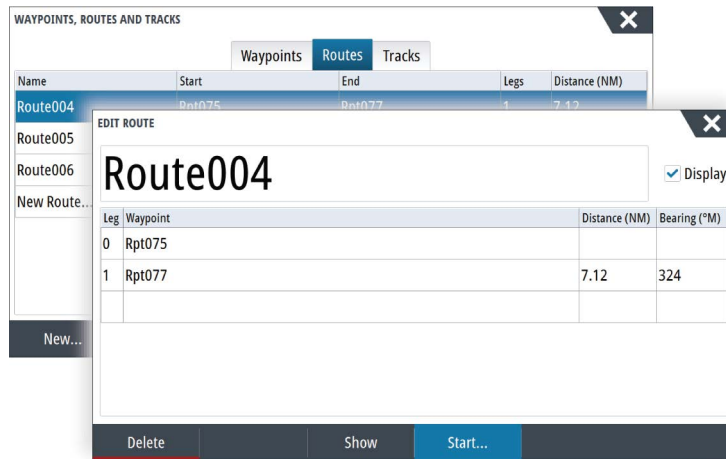

### Cancel navigation

When you are navigating, the menu includes an option for cancelling the navigation.

## Navigating with the autopilot

When you start navigation on a system with autopilot functionality, you are prompted to set the autopilot to navigation mode.

→ **Note:** The prompt to set the autopilot to navigation mode is disabled if the boat type is set to SAIL in the Autopilot Commissioning dialog.

If you choose not to engage the autopilot or if your boat is set to SAIL, the autopilot can be set to navigation mode from the Autopilot Controller later on. For more information about autopilot functionality, refer to "*Autopilot*" on page 55.

## Navigation settings

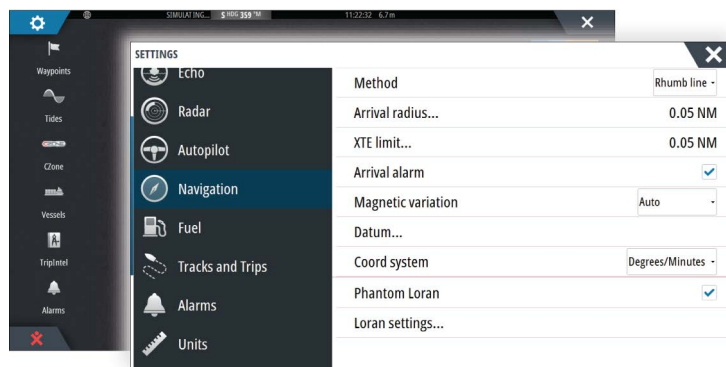

### Navigation method

Different methods are available for calculating the distance and bearing between any two points on a chart.

The Great circle route is the shortest path between two points. However, if you are to travel along such a route, it would be difficult to steer manually as the heading would constantly be changing (except in the case of due north, south, or along the equator).

Rhumb lines are tracks of constant bearing. It is possible to travel between two locations using Rhumb line computation, but the distance would usually be greater than if Great circle is used.

### Arrival radius

Sets an invisible circle around the destination waypoint.

The vessel is considered arrived at the waypoint when it is within this radius.

### **XTE limit**

This setting defines how far the vessel can deviate from the selected route, if the vessel goes beyond this limit, an alarm is activated.

### **Arrival alarm**

When the arrival alarm is enabled, an alarm is activated when the vessel reaches the waypoint or when it is within the specified arrival radius.

### **Magnetic variation**

Magnetic variation is the difference between true bearings and magnetic bearings, caused by different locations of the Geographic and the Magnetic north poles. Any local anomalies such as iron deposits might also affect the magnetic bearings.

When set to Auto, the system automatically converts magnetic north to true north. Select manual mode if you need to enter your own local magnetic variation.

### **Datum**

Most paper charts are made in the WGS84 format, which also is used by the NSO evo3.

If your paper charts are in a different format, you can change the datum settings accordingly to match your paper charts.

### **Coordinate system**

Several coordinate systems can be used to control the format for latitude and longitude coordinates displayed on the chart panel.

### **Phantom Loran**

Enables use of Phantom Loran positioning system.

### **Loran settings**

Defines Loran chains (GRI) and preferred station for waypoint entry, cursor position and position panel.

The graphic example shows a cursor position window with Loran position information. For more information refer to your Loran system documentation.

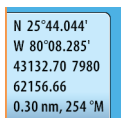

# 7

## TripIntel

TripIntel lets you store and recall information on trips. You can use the information to make informed decisions prior to commencing a trip, or when a trip is underway.

- **Note:** Vessel Fuel setup is required for this feature. Refer to the unit's separate installation manual.
- **Note:** For best results, it is recommended to run software version 2.4.0 or newer in your EP-85R Storage Device or latest software in your Fuel Data manager.

Select the TripIntel button on the Tool panel to display the TripIntel page.

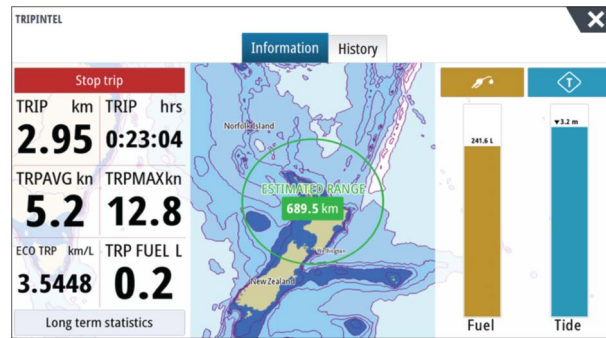
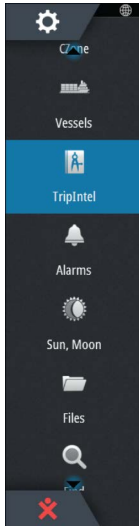

### Current trip statistics

The Information tab on the TripIntel page shows current trip statistics:

- Distance traveled
- Time traveled
- Average speed
- Maximum speed
- Fuel economy
- Fuel used

### Automatic trip recording

There is an automatic trip detection feature. When you start navigating you are prompted to start recording the trip if no trip is currently underway and your speed has been more than 2 knots for 20 seconds. You will be prompted to continue a trip or start a new trip if the trip was not explicitly saved before a power off.

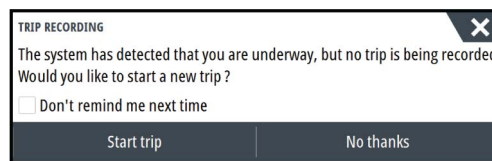

You can manually start the recording later from the TripIntel page.

You can turn off the automatic trip detection feature from the Tracks and Trip settings dialog.

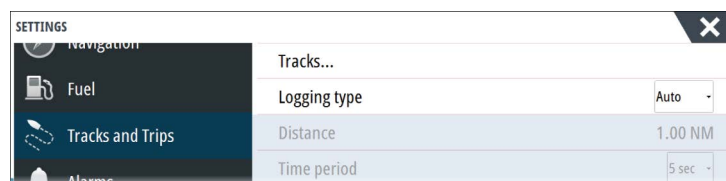

## Start and stop trip recordings

If you have selected to not start recording a trip from the automatic trip detection prompt, you can manually start a recording from the Triptel page.

The **Start** and **Stop** trip options let you specify a trip recording. You can use them to segment a single passage into multiple trips providing a finer level of control of the information that is logged for a journey.

## Long-term statistics

Select Long Term Statistics to view seasonal trip information such as engine running hours, total distance traveled, and fuel economy.

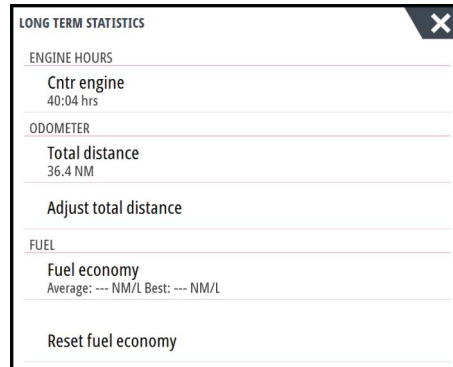

### Adjust total distance

Select the Adjust total distance button to change the Total distance. Use this option if you have not recorded a trip or part of a trip that you have taken and want to include the distance in the Total distance statistic.

### Reset fuel economy

Select **Reset fuel economy** to reset the fuel economy in the Fuel economy gauge on the Instrument bar.

## Estimated fuel range ring

The Estimated fuel range ring on the Triptel page represents the estimated total distance that the boat can travel based on historical consumption, and the amount of fuel left in the tanks.

- **Note:** The Estimated fuel range ring represents fuel consumption on a one way trip only, it does not include fuel estimates for the return trip to your current location. It represents the distance in which your boat will completely run out of fuel.
- **Note:** The Estimated fuel range ring is calculated from the Vessel Fuel Remaining only, not level sensors. When recording your refueling, you must 'Set to full' or 'Add fuel' for the range ring to be accurate.

## Fuel gauge

The Fuel Gauge on the Triptel page, and on the economy gauge is displayed based on the setting in the Vessel Setup page. You must select the Fuel Remaining measurement type.

- Fuel consumed by engine(s)
- Fuel tank level sensor(s)

→ **Note:** This is only for the Triptel page and the economy graph.





### Record your refueling

Select the Fuel button to record the amount of your refuel. The refuel information is used for calculating the Vessel Fuel Remaining amount.

### Tide gauge

The Tide gauge on the TripIntel page shows the tide height at the selected tide station.



### Tide graphs and stations

Tide stations on Chart cards provide tide information. Select the Tide button to view tide graphs and specify which Tide station provides tide information. If no tide station is chosen, tide information from the nearest tide station is used.

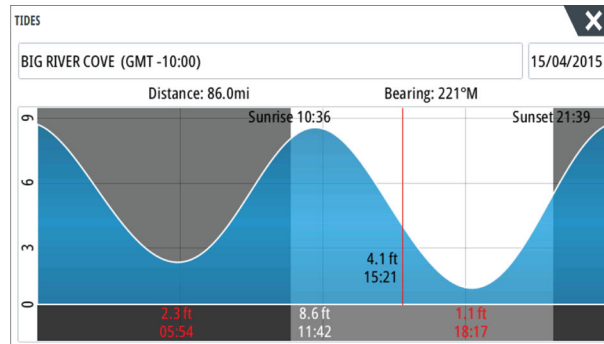

### View trip recordings

Recorded trips are listed in the History tab on the TripIntel page. To view detailed trip information select a trip in the list.

TRIP HISTORY		
Trip 1	14m 37s	4.39 NM
Ladies Bay-Karaka B	11m 10s	3.62 NM
Tibbs Beach-Coxs Bay	45m 10s	14.10 NM
Whites Bay-Sandy Bay	37m 45s	11.37 NM
Sandy Bay-Little Bay	17m 13s	5.03 NM
View Bay- Shelly Bay	1h 14m	20.00 NM

### Change trip recording names

Trips are given generic names when they are created. You can change the trip name to a more meaningful one by selecting it on the History list and then select the name in the Trip History details dialog. This opens the Trip name dialog where you can change the trip name.

TRIPINTEL

Information History

Trip HISTORY

N 25°30.587'  
 W 80°10.520'  
 7034 NM, 838 °M

Delete

Trip1

<b>Tue mar 31 2015</b>
09:51 - 09:56
<b>Duration</b>
5m 29s
<b>Distance Traveled</b>
1.62 (NM)
<b>Speed</b>
Average: 17.7 (kn)
Max: 20.0 (kn)
<b>Fuel Used</b>
57.9 (L)
<b>Fuel Economy</b>
Average: 0.0277 (NM/L)
Best: 0.0330 (NM/L)

# 8

## Autopilot

If a compatible autopilot computer is connected to the system, autopilot functionality is available in the system.

The system does not allow for more than one autopilot computer on the network.

The display unit automatically detects the autopilot computer available on the network and presents settings, configuration and user options for the connected computer.

For details about installing and configuring an autopilot computer, refer to the separate manuals that come with the autopilot computer.

### Safe operation with the autopilot

**Warning:** An autopilot is a useful navigational aid, but DOES NOT replace a human navigator.

**Warning:** A physical standby key should be available for the autopilot.

### Activating the autopilot

Activate the autopilot from any panel by selecting the autopilot option in the Control bar, followed by selecting a mode in the Autopilot controller.

The autopilot can also be activated in navigation mode from applications when you select to navigate to the cursor, a waypoint, or a route.

### Switching from automatic mode to manual steering

You switch the autopilot to Standby mode from any automatic operation mode from the Autopilot controller or by using a physical standby key.

→ **Note:** The WheelKey can be configured to be a standby key. Refer to "Configurable WheelKey" on page 20.

→ **Note:** If the unit is connected to an EVC system via the SG05, you can take manual control of the steering regardless of the autopilot mode. Refer to "Using the autopilot in an EVC system" on page 62.



### Autopilot indication on the pages

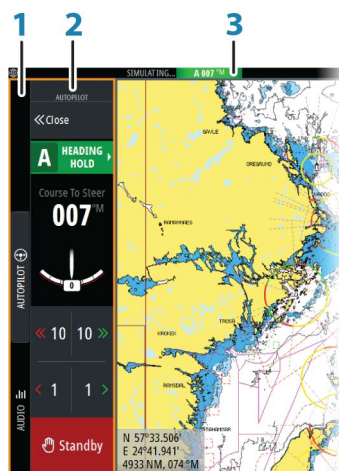

- 1 Control bar
- 2 Autopilot controller
- 3 Autopilot indication in Status bar

## Autopilot mode indication in the Status bar

The Status bar shows autopilot information as long as an autopilot computer is connected to the network.

Icons are included if the autopilot is passive or locked by another autopilot control unit.

## Autopilot controller

The Autopilot controller has a fixed position on the left-side of the page.

The following Autopilot controller options are available:

- Autopilot controller, showing active mode, heading, rudder and various steering information depending on active autopilot mode. Manual adjustments to the set heading/course can only be made when the port and starboard arrow indicators are illuminated red and green.
- Mode selection, includes access to turn pattern selection.
- Turn pattern selection, available when in Heading Hold mode.



Autopilot controller



Mode selection

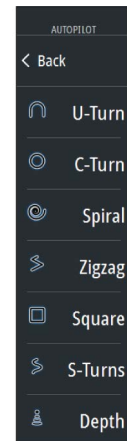

Turn pattern selection

## The Autopilot panel

The autopilot panel is used to display navigation data. It can be shown as a full screen panel, or in a multi-panel page.

→ **Note:** To make the autopilot panel available, activate the show autopilot features option in the Advanced, Features section of the System Settings dialog.

The number of data fields included in the autopilot panel is dependent on available panel size.



### Data fields

The following abbreviations are used in the autopilot panel:

CTS	Course to steer
DTD	Distance to destination
DTW	Distance to next waypoint

SOG	Speed over ground
COG	Course over ground
XTE	Cross track error (L: left or R: right)

## Autopilot modes

The autopilot has several steering modes. The number of modes and features within the mode depend on the autopilot computer, the boat type and available inputs, as explained in the description of the following steering modes.

### Standby mode

Standby mode is used when you steer the boat at the helm. Switch the autopilot to Standby mode from any operation by selecting the Standby mode button in the Autopilot controller or by using a physical standby key.

→ **Note:** The WheelKey can be configured to be a standby key. Refer to "*Configurable WheelKey*" on page 20.

### Non-Follow Up (NFU, Power steering)

In NFU mode you use the port and starboard arrow buttons in the Autopilot controller to control the rudder. The rudder will move as long as the button is pressed.

- Activate NFU mode by selecting the port or starboard arrow button in the Autopilot controller when the autopilot is in Standby or FU mode.

You return to Standby mode by selecting the standby option in the Autopilot controller or using a physical standby key.

### Follow-up steering (FU)

→ **Note:** FU mode is only available if you have a remote controller included in the system.

In FU mode you use the rotary knob on the remote controller to control the rudder angle. Press the rotary knob, then turn the knob to set the rudder angle. The rudder moves to the commanded angle and then stop.

- You select FU mode from the Autopilot controller

→ **Note:** If the Autopilot controller is closed or if an alarm dialog is activated on the unit controlling the autopilot in FU mode, the autopilot automatically changes to Standby mode.

**⚠ Warning:** While in FU mode you cannot take manual control of the wheel.

### Heading hold

In Heading hold mode the autopilot issues rudder commands required to steer the vessel automatically on a set heading.

When the mode is activated, the autopilot selects the current boat heading as the set heading.

#### Changing set heading in Heading hold

You adjust the set heading by using the Port and Starboard arrow buttons in the Autopilot controller.

An immediate heading change takes place. The new heading is maintained until a new heading is set.

#### Heading capture

When the vessel is turning in Heading hold mode, an instant reset of the mode activates the heading capture function. This automatically cancels the turn, and the vessel continues on the heading read from the compass the very moment you re-activated the mode.



## Tacking in Heading hold mode

- **Note:** The tack function is only available when the system is set up for boat type SAIL in the Autopilot Commissioning dialog and is not available for NAC-1 autopilot computers.
- **Note:** Tacking should be tried out in calm sea conditions with light wind to find out how it works on your boat. Due to a wide range of boat characteristics (from cruising to racing boats) the performance of the tack function may vary from boat to boat.

Tacking in Heading hold mode is different from tacking in WIND mode. In Heading hold mode the tack angle is fixed and as defined by the user. For more details, refer to *"Tacking in WIND mode"* on page 60.

You initiate the tack function from Heading hold mode.

When tacking direction is selected the autopilot changes the current set course according to the set fixed tacking angle.

## NoDrift mode

NoDrift mode combines the autopilot and the positioning information from the GPS.

In NoDrift mode the vessel is steered along a calculated track line in a direction set by the user. If the vessel's heading is drifting away from the original heading due to current and/or wind, the vessel follows the line with a crab angle.

1. Turn the vessel to the desired heading
2. Activate the NoDrift mode. The autopilot draws an invisible bearing line based on current heading from the boat's position

Unlike in Heading hold mode, the autopilot now uses the position information to calculate the cross track error, and automatically keeps your track straight.

You use the port/starboard arrow panel buttons in the Autopilot controller or the rotary knob to reset the bearing line while in NoDrift mode.

## Dodging

If you need to avoid an obstacle when using NoDrift mode, you can set the autopilot to Standby mode and power steer or use the helm until the obstacle is passed.

If you return to NoDrift mode within 60 seconds you can select to continue on previous set bearing line.

If you do not respond, the dialog disappears and the autopilot goes to NoDrift mode with current heading as set bearing line.

## NAV mode

**⚠ Warning: NAV** mode should only be used in open waters.

You can use the autopilot to automatically steer the boat to a specific waypoint location, or along a pre-defined route. The position information from the GPS is used to change the course to steer to keep the boat on the track line and to the destination waypoint.

- **Note:** To obtain satisfactory navigation steering, the NSO evo3 must have valid position input. Autosteering must be tested and determined satisfactory prior to entering the NAV mode.

### Start automatic navigating

When you start navigating a route or to a waypoint from the chart panel, you are prompted to set the autopilot to NAV mode. If you reject this request, you can start NAV mode from the Autopilot controller.

- **Note:** The prompt to set the autopilot to navigation mode is disabled if the boat type is set to SAIL in the Autopilot Commissioning dialog. To start navigating, you must select NAV mode from the Autopilot controller.

When NAV mode is initiated, the autopilot automatically keeps the vessel on the leg.

When the vessel reaches the arrival circle for a routepoint, the autopilot gives an audible warning and displays a dialog with the new course information. If the required course change to the next waypoint is less than the Navigation change limit, the autopilot automatically changes the course. If the required course change to next waypoint in a route is more than the set limit, you are prompted to verify that the upcoming course change is acceptable.

→ **Note:** For information about navigation settings, refer to "*Navigation settings*" on page 49.

### Waypoint arrival circle

The Arrival radius defines the point at which a turn is initiated when you are navigating a route.

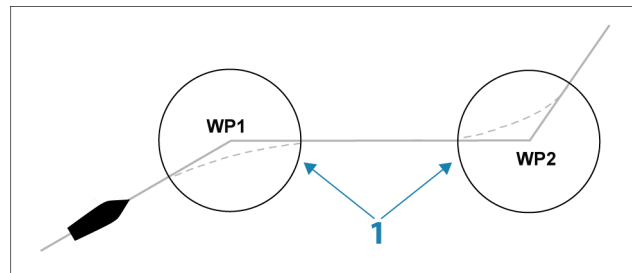

The arrival circle (1) should be adjusted according to boat speed. The higher the speed, the wider the circle. The intention is to make the autopilot start the heading change in due time to make a smooth turn onto the next leg.

The figure below may be used to select the appropriate waypoint circle when creating the route.

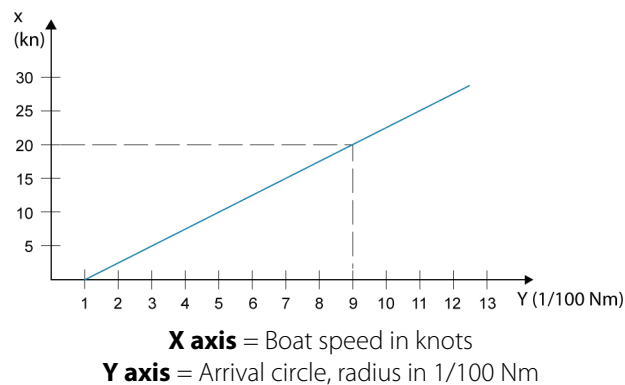

Example: With the speed of 20 knots you should use a waypoint circle with radius 0.09 Nm.

→ **Note:** The distance between any waypoints in a route must not be smaller than the radius of the waypoint arrival circle.

### WIND mode

→ **Note:** WIND mode is only available if the system has been set up for boat type SAIL in the Autopilot Commissioning dialog. This mode is not available for NAC-1 and AC70 autopilot computers. It is not possible to active WIND mode if wind information is missing.

When wind mode is engaged, the autopilot captures the current wind angle as steering reference, and adjusts the heading of the boat to maintain this wind angle.

Switch to WIND mode by selecting it in the Autopilot controller.

**⚠ Warning:** In wind mode the autopilot steers to the apparent or true wind angle and not to a compass heading. Any wind shift could result in the vessel steering on an undesired course.

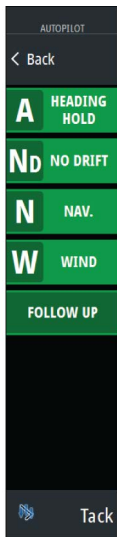

### Tacking in WIND mode

→ **Note:** The tack function in WIND mode is only available when the system is set up for boat type SAIL in the Autopilot Commissioning dialog and is not available for NAC-1 or AC70 autopilot computers.

Tacking in Wind mode can be performed when sailing with apparent or true wind as the reference. In either case the true wind angle must be less than 90 degrees.

The tacking/gybing operation will mirror the set wind angle on the opposite tack.

→ **Note:** Tacking should be tried out in calm sea conditions with light wind to find out how it works on your boat. Due to a wide range of boat characteristics (from cruising to racing boats) the performance of the tack function may vary from boat to boat.

The rate of turn during the tack will be given by the Tack time defined in the sailing parameter setup. The tack time is also controlled by the speed of the boat to prevent loss of speed during a tack.

You can initiate the tack function from WIND mode.

When you initiate the tacking, the autopilot immediately mirrors the set wind angle to the opposite side of the bow.

You can interrupt the tack operation by selecting standby, re-engaging Wind mode, or engaging heading hold or no drift.

### Gybing

Gybing is possible when the true wind angle is larger than 120°.

The time to make a gybe is determined by the speed of the boat to make it as quick as possible within control.



### Turn pattern steering

The autopilot includes a number of automatic turn steering features when the autopilot is in Heading hold mode.

→ **Note:** The turn steering option is not available if the boat type is set to SAIL in the Autopilot Commissioning dialog, instead the tack/gybe feature is implemented.

### Initiating a turn

You start the turn by selecting the relevant turn icon, followed by selecting the port or starboard options in the turn dialog to select the turn direction.

### Stopping the turn

You can stop the turn in the turn page of the Autopilot controller.

At any time during a turn you can select Standby in the Autopilot controller or Autopilot standby in the System controls dialog to return to Standby mode and manual steering.

You can also stop a turn by pressing a physical standby key to return to Standby mode and manual steering.

### Turn variables

The turn steering options, except the U-turn, have settings that you can adjust before you start a turn and some can be adjusted when the boat is in a turn.

### U-turn

U-Turn changes the current set heading to be 180° in the opposite direction.

The turn rate is identical to Rate limit settings. This cannot be changed during the turn.

→ **Note:** Refer to the separate NSO evo3 Installation manual for information about Rate limit settings.

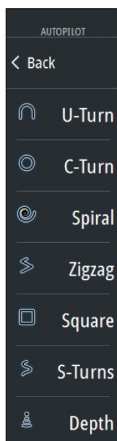



### C-turn

Steers the vessel in a circle.

You can adjust the Rate of turn from the turn dialog before the turn is initiated and during the turn. Increasing the turn rate makes the vessel turn a smaller circle.

### Spiral turn

Spiral-turn makes the vessel turn in a spiral with a decreasing or increasing radius. You set the initial radius before the turn is initiated, and the change per turn during the turn. If the change per turn is set to zero, the vessel turns in a circle. Negative values indicate decreasing radius while positive values indicate increasing radius.

### Zigzag turns

Steers the vessel in a zigzag pattern.

For navigating in a zigzag pattern, you set the initial heading change before the turn is started.

During the turn you can alter the main heading, the heading change, and the leg distance.

### Square turn

Makes the vessel automatically turn 90° after having travelled a defined leg distance.

At any time during the turn you can change the main heading and the distance of the leg until the vessel makes a new 90° turn.

### Lazy S-turn

Makes the vessel yaw around the main heading.

During the turn you can alter the heading change and the turn radius.

### Depth contour tracking, DCT™

If the system has Echosounder input, the autopilot can be set to follow a depth contour.

**⚠ Warning:** Do not use this feature unless the seabed is suitable. Do not use it in rocky waters where the depth is varying significantly over a small area.

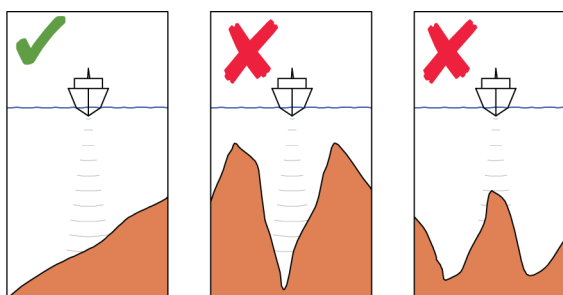

Use the following process to initiate DCT steering:

1. Ensure that you have depth reading on the panel or on a separate depth instrument.
2. Steer the boat to the depth you want to track, and in the direction of the depth contour.
3. Activate Heading hold mode, select depth contour steering and monitor the depth reading.
4. Select the port or starboard option in the turn dialog to initiate the depth contour steering to follow the bottom sloping to starboard or to port:

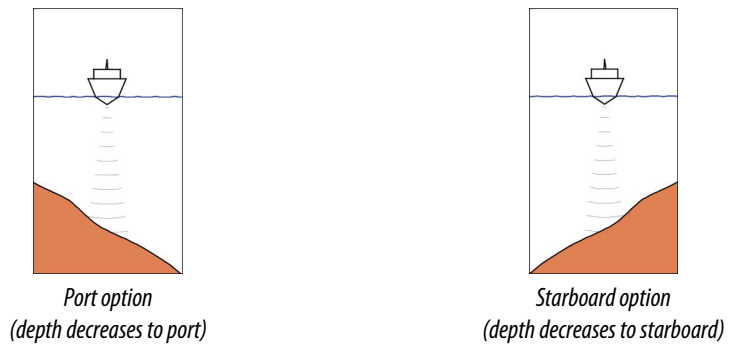

The following parameters are available for depth contour tracking:

### Depth gain

This parameter determines the ratio between commanded rudder and the deviation from the selected depth contour. The higher depth gain value the more rudder is applied.

If the value is too small, it takes a long time to compensate for drifting off the set depth contour, and the autopilot fails to keep the boat on the selected depth.

If the value is set too high, the overshoot increases and the steering is unstable.

### Contour Cross Angle (CCA)

The CCA is an angle that is added to or subtracted from the set course.

With this parameter you can make the boat yaw around the reference depth with lazy-s movements.

The larger the CCA, the bigger yawing is allowed. If you the CCA set to zero there are no lazy-s movements.

## Using the autopilot in an EVC system

When the NSO evo3 is connected to an EVC system via the SG05, you can take manual control of the steering regardless of the autopilot mode.

The mode indicator on the Autopilot controller is replaced by a dash to indicate EVC override.

The system returns to NSO evo3 control in standby mode if no rudder command is given from the EVC system within a predefined period.

## Using the NSO evo3 in an AP70/AP80 system

If your MFD is connected to an AP70/AP80 autopilot system, the MFD can be used to operate the autopilot.

In an AP70/AP80 autopilot system, only one control unit can be active at the same time.

→ **Note:** The MFD cannot be used to configure or commission an AP70/AP80 system.



The thruster symbol on the Autopilot controller indicates thrusters are defined in the AP70/AP80 autopilot system.

For more information about AP70/AP80 autopilot system, refer to the separate AP70/AP80 documentation.

### Autopilot detection

The AP70/AP80 system has its own source groups. If the MFD is going to be used to run the AP70/AP80 system, the MFD must use the same source groups as the AP70/AP80 system.

When a MFD is connected to an AP70/AP80 system, it detects the AP70/AP80 system and a prompt is displayed asking if the MFD should restart and use the AP70/AP80 system source groups (restart in professional autopilot compatibility mode).

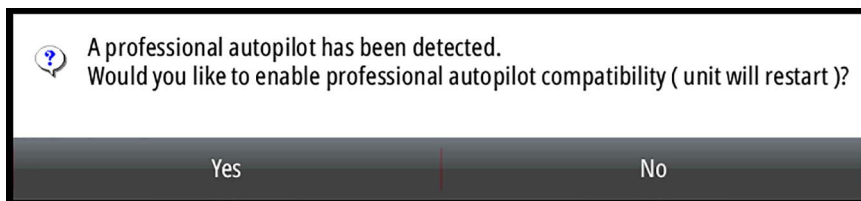

If yes is selected, then the MFD restarts using the same source groups as the AP70/AP80 system. If No is selected then the question is not asked again and the MFD cannot be used to operate the AP70/AP80 system.

This setting can be changed by selecting Professional autopilot compatibility in the Advanced settings dialog. When this option is ticked ON, the MFD can be used to operate the AP70/AP80 system.

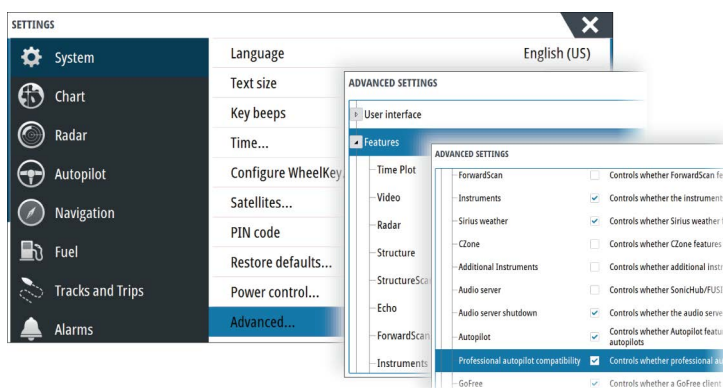

### Running thruster symbols

When thrusters are running in an AP70/AP80 system, red and green arrows are displayed in the MFD Autopilot controller to indicate thrust direction.

### Command transfer



An AP70/AP80 system can be set up as a Master system or an Open system.



In a Master setup, the master controller gives control to other control units. An MFD cannot be the master controller in a Master setup. In a Master setup, the MFD can request to control the autopilot and the MFD must accept control from the master controller after the master controller approves transfer of control to the MFD. Once control is accepted, the MFD is active and can be used to operate the autopilot.

In an Open system setup, the MFD can take control of the autopilot by selecting the Mode button on the Autopilot controller and then selecting **Take cmd** in the CMD transfer dialog. When this occurs the MFD becomes active and the other control units become passive.

In an Open system, control stations can be temporarily locked to avoid accidental control from another control unit. When the MFD has control in an Open system, the MFD can lock and unlock all passive control units. If the MFD is passive and locked, it can request control of the autopilot from the active control unit. The MFD must accept control from the active controller after the active controller approves transfer of control to the MFD.

The following indicators are displayed in the Autopilot controller:

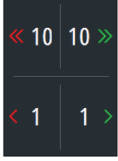
	<p>Passive - MFD does not have control of the autopilot. If only the passive icon is displayed, it means it is an Open unlocked system and selecting the Mode button takes control of the autopilot.</p>
	<p>Locked system - The key icon indicates it can be a Master system or a locked Open system.</p>

	<p>If the &lt;&lt;10, &lt;1, 10&gt;&gt;, 1&gt; buttons are enabled then the MFD is active and controls the autopilot.</p>
	<p>If the lock button is displayed instead of the &lt;10, &lt;1, 10&gt;, 1&gt; buttons, then the MFD is passive and does not control the autopilot. Select the lock button to request control from the active control unit if it is a locked Open system, or the master controller if it is a Master system.</p>
<p>none</p>	<p>Active in Open system - the MFD has control of the autopilot in an Open system.</p>

### Locking and un-locking other control units

Select the Autopilot information option in the Autopilot controller to open the Command transfer selection pages.

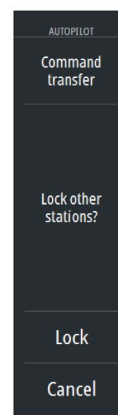
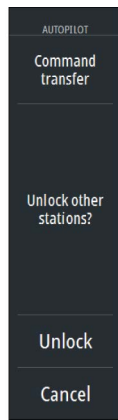

**Unlock other stations/Unlock** - allows other control units to take control of the autopilot without requesting permission.

**Lock other stations/Lock** - locks other control units from taking control of the autopilot. When other control units are locked, they must request control of the autopilot from the MFD. When control of the autopilot is requested from another control unit, a prompt is displayed in the MFD to authorize command transfer.

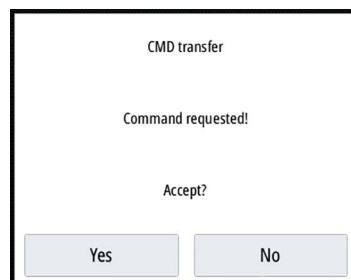



## Selecting the work profile

The AP70/AP80 can be set up with 6 different work profiles associated with different work modes or preferences. Use the AP70/AP80 controller to set up the different work profiles. In the MFD, the active work profile is displayed in the MFD Autopilot controller. If the MFD has control of the autopilot, you can use it to specify the active work profile.

To change the work profile using the MFD, the autopilot must be in standby mode.

1. Open the Autopilot controller and set the autopilot in standby mode
2. Select the Work profiles button to display defined work profiles in the Work profiles selection page



3. Select the work profile you want to activate

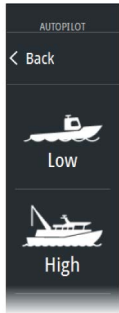

## Enabling and disabling thrusters



Select the Thruster button to disable the thruster.



Select the Disabled thruster button to activate the thruster.

## Autopilot settings

The autopilot settings can be split between settings done by the user, and settings done during installation and commissioning of the autopilot system.

- User settings can be changed for various operational conditions or user preferences
- Installation settings are defined during commissioning of the autopilot system. No changes should later be done to these settings

Both user settings and installation settings depends on which autopilot computer that is connected to the system.

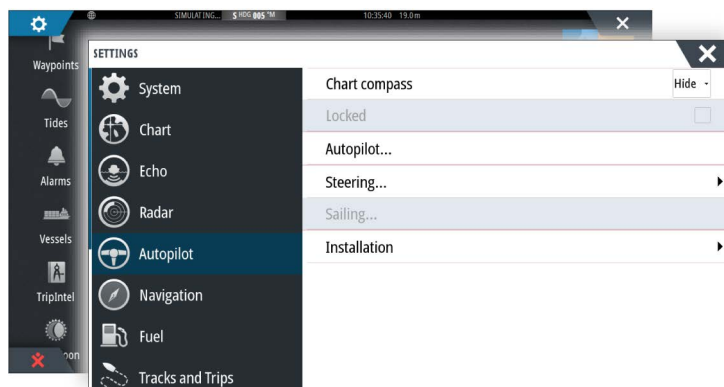

The following sections describe the settings that can be changed by the user. The settings are described per autopilot computer.

Installation settings are available in the documentation following the autopilot computers.

## Common user settings

The following user settings are common to all autopilots.

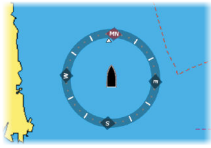

### Chart compass

You can select to show a compass symbol around your boat on the chart panel. The compass symbol is off when the cursor is active on the panel.

### Locking autopilot operation from a unit

You can lock a unit to prevent unauthorized operation of the autopilot. When the unit is locked, it is indicated with a lock symbol and with text in the Autopilot controller. No automatic modes can be selected from a locked display.

→ **Note:** The lock function is not available on a unit which has autopilot control!

## NAC 1 Specific user settings

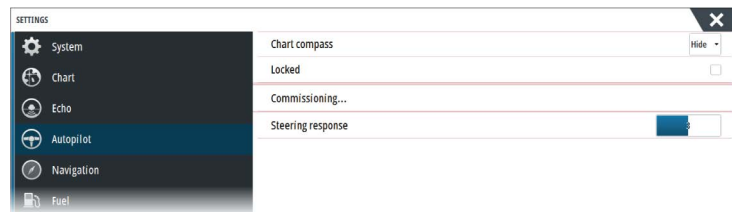

### Steering response

Used to increase or decrease the steering sensitivity. A low response level reduces the rudder activity and provides a more *loose* steering. A high response level increases the rudder activity and provides more *tight* steering. Too high a response level will cause the boat to make S movements.

## NAC2/NAC3 Specific user settings

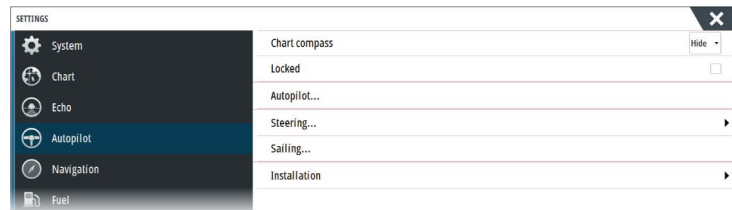

### Steering

These options allow for manually changing low speed and high speed parameters that were set during the commissioning of the autopilot computer. For more details, refer to the separate documentation for the autopilot computer.

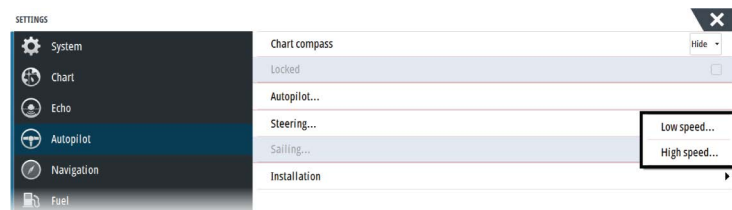

Selecting the low speed option or the high speed option opens dialogs the following parameters can be changed.

- Turn rate: Preferred turn rate used while turning in degrees per minute
- Rudder gain: This parameter determines the ratio between commanded rudder and the heading error. The higher rudder value the more rudder is applied. If the value is too small

it will take a long time to compensate for a heading error, and the autopilot will fail to keep a steady course. If the value is set too high the overshoot will increase and the steering will be unstable.

- Counter rudder: Relation between change in heading error and applied rudder. Higher counter rudder will reduce applied rudder faster when approaching the set heading
- Auto trim: Controls how aggressively the autopilot will apply rudder to compensate for a constant heading offset, e.g. when external forces such as wind or current affects the heading. Lower auto trim will give faster elimination of a constant heading offset
- **Note:** In VRF mode this parameter controls the time constant of the rudder estimate. A lower value makes the rudder estimate faster, i.e. that it will more quickly catch up with the boat's movements.
- Init rudder: Defines how the system moves the rudder when switching from manual steering to an automatic mode.
  - Center: Moves the rudder to zero position
  - Actual: Maintains the rudder offset
- Rudder limit: Determines the maximum rudder movement in degrees from midship position that the autopilot can command the rudder in the automatic modes. The Rudder limit setting is only active during autosteering on straight courses, NOT during course changes. Rudder limit does not affect Non-Follow-up steering
- Off heading limit: Sets the limit for the off heading alarm. An alarm occurs when the actual heading deviates from the set heading more than the selected limit
- Track response: Defines how fast the autopilot shall respond after having registered a cross track distance
- Track approach angle: Defines the angle used when the vessel is approaching a leg. This setting is used both when you start navigating and when you use track offset
- Course change confirm angle: Defines the limits for course change to next waypoint in a route. If the course change is more than this set limit, you are prompted to verify that the upcoming course change is acceptable.

## Sailing

- **Note:** Sailing parameters are only available when the boat type is set to Sail.

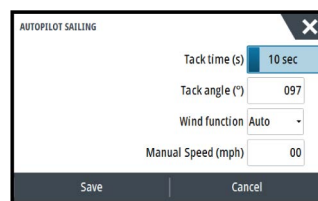

This option allows for manually changing parameters that were set during the commissioning of the autopilot computer. For more details of the settings, refer to the separate documentation for the autopilot computer.

- Tack time: Controls the rate of turn (tack time) when performing a tack in wind mode.
- Tack angle: Controls the angle that the boat will tack to between 50° - 150° in Heading hold mode
- Wind function: Select what wind function the autopilot will use when in wind mode
  - Auto:
    - If TWA is <70°: Wind mode will use AWA
    - If TWA is ≥70°: Wind mode will use TWA
  - Apparent
  - True

- Manual speed: If neither boat speed or SOG data is available and or deemed reliable a manual value for speed source can be entered and used by the autopilot to aid steering calculations

### AC70/AC80 Specific user settings

The AC70/AC80 does not have specific user settings available in the MFD.

→ **Note:** The MFD cannot be used to configure or commission an AP70/AP80 system. For more information, refer to the documentation included with the autopilot computer.

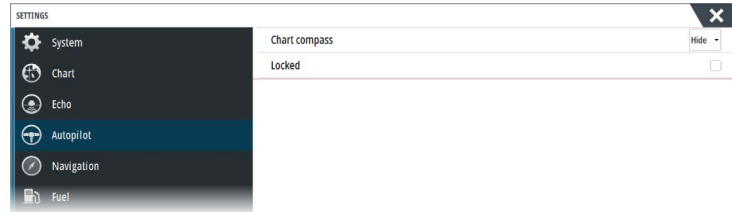



# 9

## Radar

The radar panel can be set up as a full screen view or combined with other panels.

The radar image can also be displayed as an overlay on a chart panel. For more information, see *"Radar overlay"* on page 70.

→ **Note:** Radar overlay requires data from a heading sensor or compass to ensure proper orientation with the chart.

### The radar panel

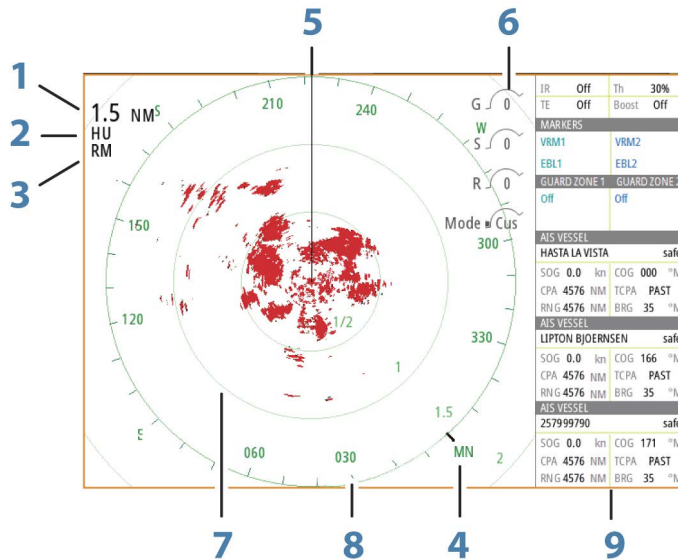

- 1 Range
- 2 Orientation
- 3 Motion
- 4 Compass\*
- 5 Heading line\*
- 6 Rotary controls
- 7 Range rings\*
- 8 Range markers\*
- 9 Data bar

\* Optional radar symbology.

Radar symbology can be turned ON/OFF collectively from the Radar menu, or individually as described in *"Radar settings panel"* on page 81.

### Dual radar

You can connect to any combination of two supported radars and see both radar images at the same time.

→ **Note:** Interference will be seen on the Broadband Radar on most ranges when a pulse or Halo radar, and a Broadband radar are transmitting at the same time on the same boat. We recommend to only transmit on one radar at a time. For example, transmit Broadband radar for typical navigational usage, or pulse or Halo radar to locate weather cells, defined coastlines at a distance and to trigger Racons.

You can select a dual radar panel by pressing and holding the Radar application button on the **Home** page, or by creating a favorite page with two radar panels.

## Selecting the radar source

You specify the radar in the Radar panel by selecting one of the available radars in the radar source menu option. If you have a multiple Radar panel, the radar is set individually for each radar panel. Activate one of the radar panels, and then select one of the available radars in the radar source menu option. Repeat the process for the second radar panel, and select an alternative radar for this panel.

→ **Note:** The 3-digit radar source number is the last 3 digits of the radar's serial number.

## Radar overlay

You can overlay the Radar image on the Chart. This can help you to easily interpret the radar targets by correlating the radar targets with charted objects.

→ **Note:** A heading sensor must be present in the system for radar overlay.

When the radar overlay is selected, basic radar operational functions are available from the Chart panel's menu.

## Selecting radar overlay source on chart panels

To select the radar source of the radar overlay displayed on the chart panel, use the **Radar options** and then **Source** chart panel menu options to select the radar source.

For chart pages with more than one chart with radar overlay, it is possible to set up different radars sources for each chart panel. Activate one of the chart panels and then select one of the available radars in the radar source menu option. Repeat the process for the second chart panel with radar overlay, and select an alternative radar for this panel.

## Radar operational modes

The radar's operational modes are controlled from the Radar menu. The following modes are available:

### Power off

The power to the radar scanner is turned off. **Power off** is only available when radar is in standby mode.

### Standby

The power to the radar scanner is on, but the radar is not transmitting.

→ **Note:** You can also put the radar in standby mode from the **System Controls** dialog.

### Halo light

Controls the levels of the Halo Radar pedestal blue accent lighting. There are four levels possible for the lighting. The accent lighting can only be adjusted when the radar is in standby mode.

→ **Note:** The blue accent pedestal lighting might not be approved for use in your boating location. Check your local boating regulations before turning the blue accent lights ON.

### Transmit

The scanner is on and transmitting. Detected targets are drawn on the radar PPI (Plan Position Indicator).

→ **Note:** You can also put the radar in transmit mode from the **System Controls** dialog.

## Radar Range

You adjust radar range by selecting the zoom icons on the radar panel.

### Dual range

(Broadband 4G and Halo Radar only)



When connected to a Broadband 4G or Halo radar, it is possible to run the radar in Dual Range mode.

The radar appears in the radar sources menu as two virtual radar sources A and B. Range and radar controls for each virtual radar source are fully independent and the source can be selected for a particular chart or radar panel in the same manner as dual radar described in "Selecting the radar source" on page 70.

→ **Note:** Some controls that are related to physical properties of the radar itself are not independent of source. These are Fast Scan, Antenna Height and Bearing alignment.

MARPA is fully independent and up to 10 targets may be tracked for each virtual radar source.

Up to two independent Guard Zones may also be defined for each virtual radar source.

## Using the cursor on a radar panel

By default, the cursor is not shown on a radar panel.

When you position the cursor on the radar panel, the cursor position window is activated and the cursor menu options are displayed.

To remove the cursor and cursor elements from the panel, select **Clear cursor** or press the **X** key.

### GoTo cursor

You can navigate to a selected position on the image by positioning the cursor on the panel, then using the **Goto Cursor** option in the menu.

### The cursor assist function

→ **Note:** The cursor assist function is available if it is enabled. Refer to "Customizing the long press feature" on page 20.

The cursor assist function allows for fine tuning and precision placement of the cursor without covering details with your finger.

Activate the cursor on the panel, then press and hold your finger on the screen to switch the cursor symbol to a selection circle, appearing above your finger.

Without removing your finger from the screen, drag the selection circle to the desired position.

When you remove your finger from the screen the cursor reverts to normal cursor operation.

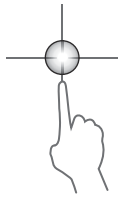

## Saving waypoints

Use the new waypoint menu option to save a waypoint on the panel. If the cursor is active, the waypoint is saved at the cursor position. If the cursor is not active, the waypoint is saved at your vessel's position.

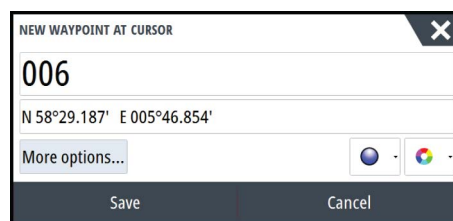

## Radar sector blanking

(Halo Radar only)

You can define up to four sectors on the PPI inside which no radar data is transmitted. This enables you to blank-out interference caused by features on your boat or from a secondary radar. The blanking occurs on the main radar image and radar overlay on a chart. An enabled sector is shown as a magenta outline with 3 arcs crossing the blanking area. To specify radar sector blanking, refer to the Halo Radar Installation Manual.

→ **Note:** Radar sector blanking is only available for Halo radars.

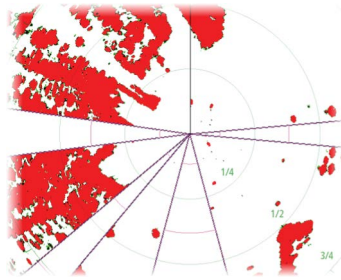

Main radar PPI



Radar overlay on a chart

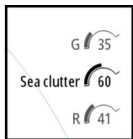

## Adjusting the radar image

You may be able to improve the radar image by adjusting the radar sensitivity, and by filtering out the random echoes from sea and weather conditions.

The radar control images are located in the upper right corner of the radar panel. You select between the control images by selecting the control image or by pressing the rotary knob on a remote controller. Active control expands and displays its name in full. You can then adjust the value by using the slide bar or by turning the rotary knob on the remote controller. You can also adjust the image settings from the radar menu.

## Radar use modes

(Halo Radar only)

Radar modes are available with default optimal control settings for different environments. The following modes are available:

- **Custom** - In this mode all radar controls can be adjusted and will be retained after a mode change or radar power cycle. Radar defaults are set for general purpose use.
- **Harbor** - In this mode the radar settings are optimized for areas such as busy waterways and large man-made structures where good target discrimination and rapid image updates are needed.
- **Offshore** - In this mode the radar settings are optimized for offshore sea conditions and making isolated targets larger and easy to see.
- **Weather** - In this mode the radar settings are optimized for best detection and presentation of rain clutter. Image update rate is slowed and color depth is increased.
- **Bird** - In this mode the radar settings are optimized for best detection of birds. The radar is set up for maximum sensitivity. This mode is not recommended for use in congested harbor environments.

Not all controls are adjustable in each mode. The following list shows preset controls and adjustability for each control.

### Range

Custom: Adjustable  
 Harbor: Full\*  
 Offshore: Full\*  
 Weather: Full\*  
 Bird: Up to 24nm

### Gain

Custom: Adjustable  
 Harbor: Adjustable  
 Offshore: Adjustable  
 Weather: Adjustable  
 Bird: Adjustable

### Threshold

Custom: Adjustable  
 Harbor: 30%  
 Offshore: 30%  
 Weather: 0%  
 Bird: 0%

### Target Expansion

Custom: Adjustable  
 Harbor: Low  
 Offshore: Medium  
 Weather: OFF  
 Bird: OFF

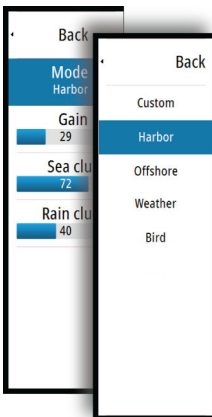

### Sea

Custom: Adjustable  
Harbor: Adjustable  
Offshore: Adjustable  
Weather: Adjustable  
Bird: Adjustable

### Rain

Custom: Adjustable  
Harbor: Adjustable  
Offshore: Adjustable  
Weather: Adjustable  
Bird: Adjustable

### Noise Rejection

Custom: Adjustable  
Harbor: Medium  
Offshore: High  
Weather: Medium  
Bird: High

### Interference Reject

Custom: Adjustable  
Harbor: Adjustable  
Offshore: Adjustable  
Weather: Adjustable  
Bird: Adjustable

### Target Separation

Custom: Adjustable  
Harbor: Medium  
Offshore: OFF  
Weather: OFF  
Bird: OFF

### Fast scan

Custom: Adjustable  
Harbor: High  
Offshore: High  
Weather: OFF  
Bird: OFF

\* Maximum range is dependent on antenna length.

### Modes in dual ranges

(Halo Radar only)

Modes can be set independently for each range. For example, you can have Offshore mode for range A and Weather mode for range B. However, interaction between ranges occurs in some cases:

- When using Bird mode for both ranges, maximum range is restricted to 24 NM and range resolution is reduced.
- Fast scan - The antenna rotation speed is set to the slower of the two modes selected. For example, Fast Scan is disabled when using Harbor and Weather modes because Fast Scan is Off in Weather mode.
- The Interference reject setting can affect the interference seen or removed on both ranges.

### Directional clutter rejection

(Broadband 4G Radar only)

This mode automatically works when GAIN = AUTO and SEA = HARBOR or OFFSHORE. The purpose is to allow smaller vessels to be seen in the leeward direction of the sea clutter. The GAIN of the radar receiver is increased dynamically during the sweep, in the leeward direction, for increased target sensitivity in heavier sea states.

When GAIN or SEA = MANUAL, the Directional Clutter Rejection mode will be OFF (non-directional).

In addition, CALM, MODERATE or ROUGH STC Curve settings are available in the Radar options menu to better optimize the radar image to your liking.

### Gain

The gain controls the sensitivity of the radar receiver.

A higher gain makes the radar more sensitive to radar returns, allowing it to display weaker targets. If the gain is set too high, the image might be cluttered with background noise.

Gain has a manual and an automatic mode. You toggle between automatic and manual mode in the slide bar, or by pressing and holding the rotary knob.

### Sea clutter

Sea clutter is used to filter the effect of random echo returns from waves or rough water near the vessel.

When you increase Sea clutter, filtering the on-screen clutter caused by the echoes of waves is reduced.

The system includes predefined Sea clutter settings for harbor and offshore conditions for all radar systems except Halo, in addition to the manual mode where you can adjust the settings. For all radar systems except Halo, you select Sea clutter modes from the menu, or by a long press on the rotary knob. You can only adjust the Sea clutter value in manual mode.

#### Auto Sea Offset

(Halo Radar only)

To allow fine tuning of the Sea control while in Auto mode (Auto uses directional adaptive clutter rejection), the Auto setting may be offset.

#### Rain clutter

Rain clutter is used to reduce the effect of rain, snow or other weather conditions on the radar image.

The value should not be increased too much as this may filter out real targets.

### Advanced radar options

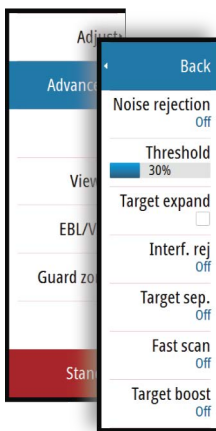

#### Noise Rejection

(Broadband 4G and Halo radar only)

The Noise Rejection control sets the amount of noise filtering applied by the radar. Target sensitivity is increased at longer ranges when this control is set to Low or High, but does cause some loss of target discrimination.

**Tip:** To get maximum range performance from Broadband 4G Radar, transmit on one range only, set the Noise Reject control to High and the threshold as low as possible. The default is 30% for less clutter on the screen. If OFF is selected for the NSO evo3, the range performance is about equal to 3G radar. In some areas where extreme high interference may exist, try OFF for best radar image.

#### Radar threshold

The threshold sets required signal strength for the lowest radar signals. Radar returns below this limit are filtered and are not displayed.

Default value: 30%.

#### Target expansion

Target expansion increases the length of targets in range, making them easier to see.

#### Rejecting radar interference

Interference could be caused by radar signals from other radar units operating in the same frequency band.

A high setting reduces the interference from other radars.

In order not to miss weak targets, the interference rejection should be set to low when no interference exists.

#### Target separation

(Broadband 4G and Halo Radar only)

The **Target separation** control allows you to control the target discrimination of the radar (separation between objects is more prominent).

#### Fast scan

(Broadband and Halo radar only).

Sets the speed of the radar antenna rotation. This option gives faster target updates.

→ **Note:** Maximum speed may not be achieved depending on the radar Settings, Mode, and Range selected. The radar will only rotate as fast as the current control settings allow.

## Sea State

Set the Sea State control according to current sea conditions for best sea clutter rejection.

## Target boost

(3G and 4G Broadband, and Pulse Radar only)

The target boost control increases pulse length or reduces radar bandwidth to make targets appear larger in range and increase radar sensitivity.

## Radar view options

View menu options vary depending on your radar antenna.

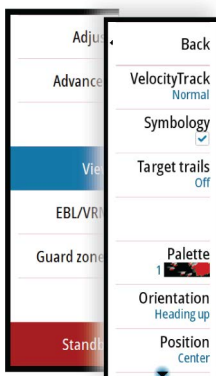

## VelocityTrack

This option is available for radar antennas that have Doppler coloring functionality.

This is an unlock feature, refer to *"Feature unlock"* on page 15.

→ **Note:** When VelocityTrack is enabled antenna rotation speed may be reduced.

Doppler coloring is a navigation aid to distinguish moving targets approaching or diverging from your vessel. The radar indicates if a target is approaching or diverging from your vessel when both these conditions are true:

- The target's relative speed is greater than the VelocityTrack speed threshold.
- The target is not geo-stationary (e.g. land or a marker buoy).

The following options are available:

- Off - turns off Doppler coloring
- Normal - approaching targets and diverging targets are colored.
- Approaching targets - only approaching targets are colored

The color of approaching and diverging targets depends on the palette used:

### Radar image palettes

- Diverging targets are blue colored on all radar image palettes.
- Approaching target colors on radar image palettes:
  - Black/Red palette - Yellow
  - White/Red palette - Yellow
  - Black/Green palette - Red
  - Black/Yellow palette - Red

### Radar overlay palettes on charts

- Diverging targets are dark grey.
- Approaching targets are yellow.

## VelocityTrack settings

Use this dialog to set speed thresholds of targets to be colored.

The speed threshold can be defined to apply for the radar source of the selected radar panel only, or to all radar sources connected to the system. The setting is only applied to those radars powered and connected at the time the setting is made. If the all radar sources option is selected, newly connected radars will use the specified values automatically.

## VelocityTrack examples

Approaching and diverging moving targets can be indicated as neutral (not colored) in some circumstances. The navigator should be aware of these situations to safely use the VelocityTrack feature as an aid for collision avoidance.

Examples of how VelocityTrack behaves in 2 navigation scenarios is illustrated below. The illustrations show a target **(A)** crossing own vessel's **(B)** path.

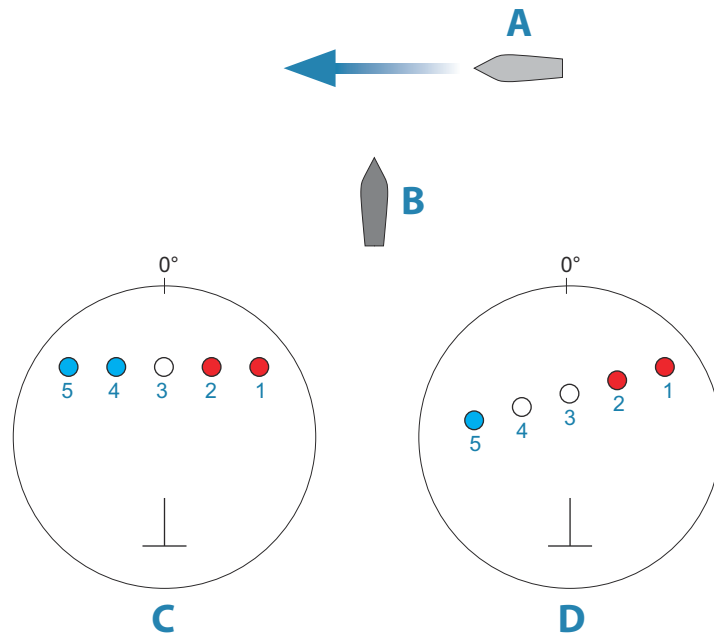

The examples show the target movement (1-5) over 5 radar scans with the radar in relative motion mode.

In example **C**, own vessel COG is 0°, and speed is 0 knots.

In example **D**, own vessel COG is 0°, and speed is 10 knots.

In both examples, the target COG is 270°, and the speed is 20 knots.

The colors in the example are according to the colors used for black/green and black/yellow radar palettes:

- Red, indicating the target is on an approaching path to own vessel. It's relative speed at that point is greater than the VelocityTrack speed threshold.
- Not colored, indicating it is temporarily neutral because it's relative speed at that point is less than the VelocityTrack speed threshold.
- Blue, indicating the target is diverging away from own vessel and it's relative speed at that point is greater than the VelocityTrack speed threshold.

### Radar symbology

Radar symbology defined in the Radar Settings panel can be turned on/off collectively. See the radar panel illustration showing optional radar items.

### Target trails

You can set how long the trails generated from each target on your radar panel remain. You can also turn OFF target trails.

→ **Note:** True motion is recommended when using Target trails

### Clearing target trails from the panel

When target trails are displayed on the panel, the radar menu expands to include an option where you can clear target trails from your radar panel temporarily. The target trails start to appear again unless you switch them off as described above.

### The radar palette

Different colors (palettes) can be used to represent detail on your radar panel.

### Radar orientation

Radar orientation is indicated on the upper left corner of the radar panel as either HU (Heading UP), NU (North Up) or CU (Course up).



### Head-up

In Head-up mode the heading line on the PPI is oriented on the 0° on the bearing scale and towards the top of the screen. The radar image is displayed relative to own ship, and when the ship turns the radar image rotates.

→ **Note:** Head-up is only available in Relative motion mode, and it is the only orientation mode available if the radar is not connected to a heading source.

### North up

In North up mode the 0° indication on the PPI represents north. The heading line on the PPI is oriented according to own ship heading obtained from the gyro compass. When the ship turns the heading line changes its direction according to the ship's heading, while the radar image remains stabilized.

The North up orientation is not available if no heading source is connected to the radar. If heading data is lost, the system will automatically switch to Head-up orientation.

### Course up

In Course up mode, the top of the bearing scale indicates the ship's true course measured from north at the time Course up was activated. When the ship turns the bearing scale remains fixed, while the heading line rotates with the ship's yawing and course change.

The Course up orientation is reset by re-selecting the Course up mode.

## Radar motion mode

Radar motion is indicated on the upper left corner of the radar panel as either TM (True motion) or RM (Relative motion).

### Relative motion

In Relative motion your vessel remains in a fixed location on the Radar PPI, and all other objects move relative to your position.

You select the position of the fixed location as described in *"Offsetting the PPI center"* on page 77.

### True motion

In True motion your vessel and all moving targets move across the Radar PPI as you travel. All stationary objects remain in a fixed position. When the vessel's symbol reaches 75% of the PPI radius (**A**), the radar image is redrawn with the vessel symbol re-positioned (**B**) 180° opposite the current heading bearing.

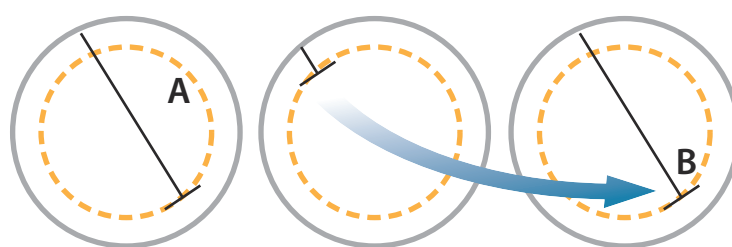

When True motion is selected, the True motion reset option is available from the menu. This allows for manually resetting the radar image and vessel symbol to its starting position.

→ **Note:** True motion is only available when the PPI is in either North Up or Course Up orientation mode.

## Offsetting the PPI center

You can set the antenna position origin to different location on the radar PPI. The options described in the next sections are available.

→ **Note:** Offsetting the PPI center is allowed only in Relative motion.

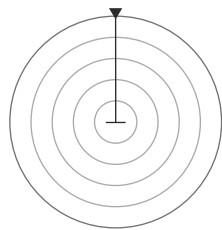

*PPI center: Center*

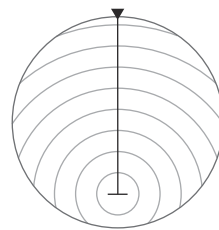

*PPI center: Look Ahead*

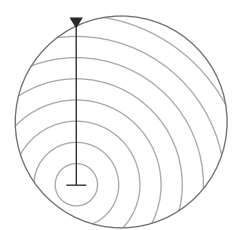

*PPI Center: Offset*

You return the antenna center to PPI center by using the offset option in the View menu.

→ **Note:** The bearing scale is according to the Consistent Common Reference Point (CCRP), while the offset sets the radar antenna position on the PPI. The maximum off-centering allowed is 75% of the radius at the current range. This may result in the CCRP being outside of the bearing scale. In such cases the measurements are still taken by the CCRP and the bearing scale is compressed accordingly.

### Center

The Center option resets the antenna position to the center of the PPI.

### Look ahead

The Look ahead option is used to maximize the view ahead of the vessel. When selected the PPI center is placed at 70% of the radius of the PPI, 180° opposite the top of the display.

→ **Note:** Look ahead is only available for Heading Up radar orientation.

### Offset to cursor position

This option allows you to use the cursor for selecting the antenna center. When the option is selected the PPI center is immediately moved to the cursor position.

## EBL/VRM markers

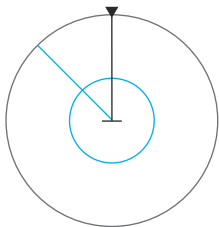

The electronic bearing line (EBL) and variable range marker (VRM) allows quick measurements of range and bearing to vessels and landmasses within radar range. Two different EBL/VRMs can be placed on the radar image.

The EBL/VRMs are by default positioned from the center of the vessel. It is, however, possible to offset the reference point to any selected position on the radar image.

When positioned, you can turn the EBL/VRM on/off by selecting the relevant markers on the data bar, or by deselecting the marker from the menu.

### Defining an EBL/VRM marker

1. Ensure that the cursor is not active
2. Activate the menu, select **EBL/VRM**, then select **EBL/VRM 1** or **EBL/VRM 2**
  - The EBL/VRM is now positioned on the radar image
3. Select the adjustment option from the menu if you need to reposition the marker, then adjust the marker by dragging it into position on the radar image
4. Select the save option to save your settings

### Placing EBL/VRM markers by using the cursor

1. Position the cursor on the radar image
2. Activate the menu
3. Select one of the EBL/VRM markers
  - The EBL line and the VRM circle are positioned according to the cursor position.

### Offsetting an EBL/VRM marker

1. Ensure that the cursor is not active
2. Activate the menu, select **EBL/VRM**, then select the marker you wish to offset
3. Select the set offset option
4. Position the cursor on the radar panel to set the offset position
5. Select the save option to save your settings.

You can reset the EBL/VRM center to vessel position from the menu.

## Setting a guard zone around your vessel

A guard zone is an area (either circular or a sector) that you can define on the radar image. When activated, an alarm alerts you when a radar target enters or exits the zone.

### Defining a guard zone

1. Ensure that the cursor is not active
2. Activate the menu, select **Guard zones**, then select one of the guard zones
3. Select the shape for the zone
  - The adjustment options depend on the guard zone shape
4. Select **Adjust** to define the settings for the guard zone. The values can be set from the menu or by dragging on the radar panel.
  - **A**: Bearing, relative to the vessel heading
  - **B**: Depth
  - **C**: Range, relative to vessel center
  - **D**: Width
5. Select the save option to save your settings.

When positioned, you can turn the guard zones on/off by selecting the relevant section on the data bar.

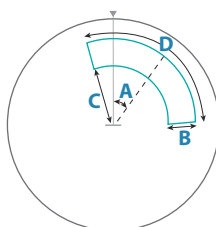

Shape: Sector

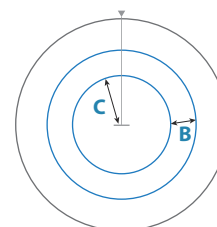

Shape: Circle

### Alarm settings

An alarm is activated when a radar target breaches the guard zone limits. You can select if the alarm is activated when the target enters or exits the zone.

### Sensitivity

The guard zone sensitivity can be adjusted to eliminate alarms for small targets.

## MARPA targets

If the system includes a heading sensor, the MARPA function (Mini Automatic Radar Plotting Aid) can be used to track up to ten radar targets.

You can set alarms to notify you if a target gets too close. Refer to *"Radar settings"* on page 81.



MARPA tracking is an important tool for collision avoidance.

→ **Note:** MARPA requires heading data for both the radar and the NSO evo3.

### MARPA target symbols

The system uses the target symbols shown below.

	Acquiring MARPA target. Typically it takes up to 10 full rotations of the scanner.
	Tracking MARPA target, not moving or at anchor.
	Tracking and safe MARPA target with extension lines.

	Dangerous MARPA target. A target is defined as dangerous when it enters the guard zone defined on the radar panel.
	When no signals have been received within a time limit a target will be defined as lost. The target symbol represents the last valid position of the target before the reception of data was lost.
	Selected MARPA target, activated by positioning the cursor on the target icon. The target returns to the default target symbol when the cursor is removed.

### Tracking MARPA targets

1. Position the cursor on the target on the radar image
2. Select **Acquire targets** from the menu
3. Repeat the process if you want to track more targets

After your targets are identified, it may take up to 10 radar sweeps to acquire and then track the target.

### Cancelling MARPA target tracking

When targets are being tracked, the radar menu expands to include options for cancelling individual targets or to stop the tracking function.

Cancel tracking individual targets by selecting the target icon before activating the menu.

### Viewing MARPA target information

If the pop-up is activated, you can select a MARPA target to display basic target information. Information for the 3 MARPA targets closest to the vessel is also displayed in the data bar.

When a target is selected, detailed information for the target can be displayed from the menu.

You can display information about all MARPA targets by using the **Vessels** option on the Home page.

### MARPA alarm settings

You can define the following MARPA alarms:

- **MARPA target lost**  
Controls whether an alarm is activated when a MARPA target is lost.
- **MARPA unavailable**  
Controls whether an alarm is activated if you do not have the required inputs for MARPA to work (valid GPS position and heading sensor connected to the radar server).

## Recording radar data

You can record radar data and save the file internally in the unit, or save it onto a storage device connected to the unit.

A recorded radar file can be used for documenting an event or an operational error. A logged radar file can also be used by the simulator.

→ **Note:** The record menu option is available if recording is turned on in the Advanced system settings.

If more than one radar is available, you can select which source you want to record.

## Radar settings

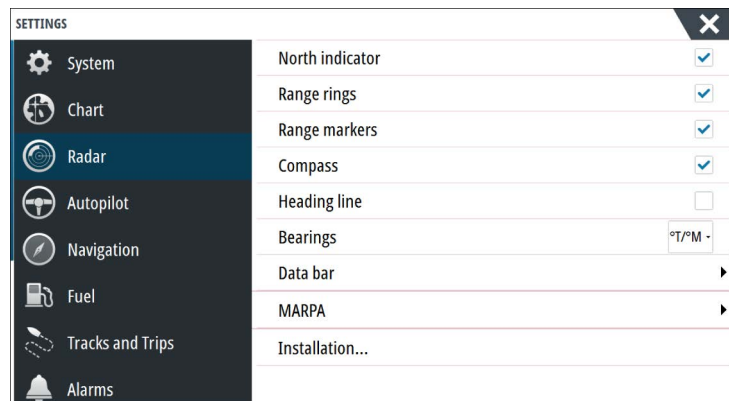

### Radar symbology

You can select which optional radar items that should be turned on/off collectively from the menu. Refer to the Radar panel illustration.

### Bearings

Used for selecting whether the radar bearing should be measured in relation to True/Magnetic North (°T/°M) or to your relative heading (°R).

### Data bar

Turns on/off the radar data bar. Refer to the radar panel illustration.

The data bar can show up to 3 targets, arranged with the most dangerous targets on top. You can select to show MARPA targets on top and before any AIS targets, even if the AIS targets are closer to your vessel.

### MARPA settings

You can define the length of the MARPA trail making it easier to follow target movement.

A circle can be added around your vessel to present the danger zone. The radius of the ring is the same as the closest point of approach as set in the Dangerous Vessels dialog. Refer to *"Defining dangerous vessels"* on page 109. An alarm triggers if a vessel is tracking into your safe zone.

### Installation

The Installation option is used for radar installation, described in the separate Radar or NSO evo3 Installation manuals.

# 10

## Echosounder

The Echosounder function provides a view of the water and bottom beneath your vessel, allowing you to detect fish and examine the structure of the sea floor.

The NSO evo3 units do not include built in echosounder or StructureScan. An external module such as the SonarHub, S5100 or other compatible modules must be available on the network to be able to use echosounder functionality on the system.

### The Echosounder image

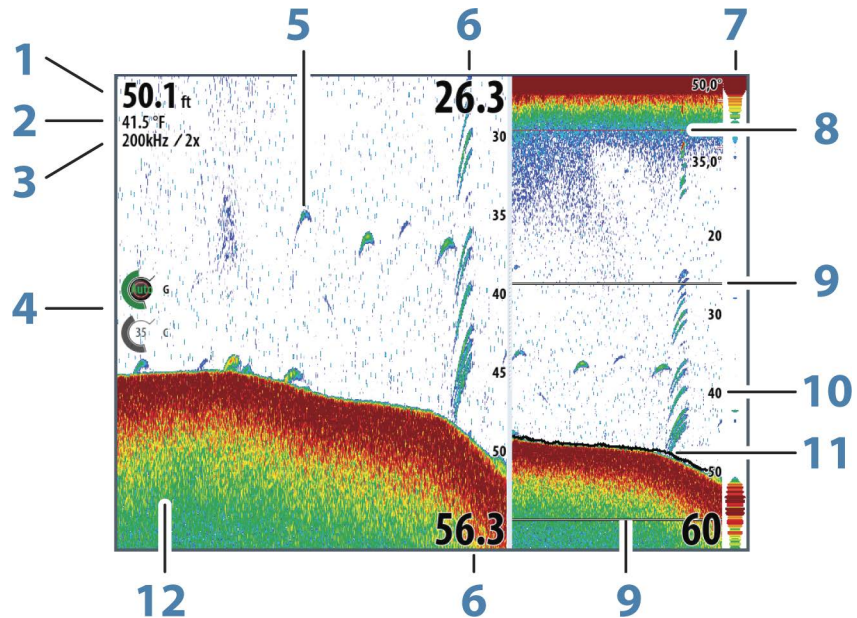

- 1 Depth
- 2 Temperature
- 3 Frequency / Zoom
- 4 Gain / Color adjustment icons
- 5 Fish arches
- 6 Upper and Lower range
- 7 A-Scope\*
- 8 Temperature graph\*
- 9 Zoom bars\*
- 10 Range scale
- 11 Depth line\*
- 12 Bottom

\* Optional Echosounder items.

→ **Note:** You turn the optional Echosounder items on/off individually. Refer to "Echosounder View options" on page 87.

### Multiple Echosounder

You can specify the Echosounder source for the image in the Echosounder panel. You can display two different sources simultaneously, using a split panel configuration. For more information how to select the source for a panel, refer to "Source" on page 85.

## Zooming the image

You can zoom the image by:

- Touch operation: pinching or spreading on the screen, or by using the panel zoom icons
- Remote controller operation: using the **IN/OUT** keys or the rotary knob
- Keyboard operation: using the **+/-** keys

Zoom level is shown on the upper left side of the image.

When zooming in, the sea floor is kept near the bottom of the screen, irrespective of whether it is in auto-range or manual range.

If the range is set considerably less than the actual depth, the unit is not able to find the bottom when zooming.

If the cursor is active, the unit zooms in where the cursor is pointed.

### Zoom bar

The zoom bar is displayed when you zoom the image.

Drag the zoom bar vertically to view different parts of the water column.

## Using the cursor on the image

The cursor can be used to measure a distance to a target, to mark a position, and to select targets.

By default, the cursor is not shown on the image.

When you position the cursor on the image; the screen pauses, the depth at the cursor position is shown, and the information window and the history bar are activated.

To remove the cursor and cursor elements from the panel, select the **Clear cursor** menu option.

### GoTo cursor

You can navigate to a selected position on the image by positioning the cursor on the panel, then using the **Goto Cursor** option in the menu.

### The cursor assist function

→ **Note:** The cursor assist function is available if it is enabled. Refer to "*Customizing the long press feature*" on page 20.

The cursor assist function allows for fine tuning and precision placement of the cursor without covering details with your finger.

Activate the cursor on the panel, then press and hold your finger on the screen to switch the cursor symbol to a selection circle, appearing above your finger.

Without removing your finger from the screen, drag the selection circle to the desired position.

When you remove your finger from the screen the cursor reverts to normal cursor operation.

### Measuring distance

The cursor can be used to measure the distance between the position of two observations on the image.

1. Position the cursor on the point from where you want to measure the distance
2. Start the measuring function from the menu
3. Position the cursor on the second measuring point
  - A line is drawn between the measuring points, and the distance is listed in the Cursor Information panel
4. Continue selecting new measuring points if required

You can use the menu to re-position the start point and the end point as long as the measuring function is active.

When you select **Finish measuring**, the image resumes to normal scrolling.

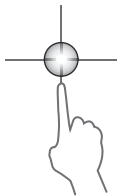

## Viewing history

Whenever the cursor is shown on the Echosounder panel, the scroll bar is shown at the top of the panel. The scroll bar shows the image you are currently viewing in relation to the total Echosounder image history stored.

If the scroll bar is on the far right side, it indicates that you are viewing the latest soundings. If you position the cursor to the left side of the screen, the history bar starts scrolling towards the left, and the automatic scrolling as new soundings are received is turned off.

You can view echosounder history by panning the image.

To resume normal scrolling, select the **Clear cursor** menu option.

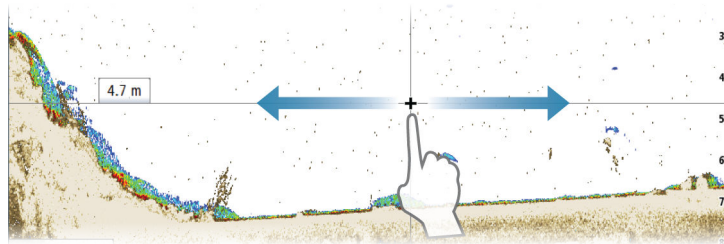

## Setting up the image

Use the Echosounder menu options to set up the image. When the cursor is active, some options on the Echosounder menu are replaced with cursor mode features. Select **Clear cursor** to return to the normal Echosounder menu.

### The range

The range setting determines the water depth that is visible on the screen.

### Frequency

The unit supports several transducer frequencies. Available frequencies depend on the transducer model that is connected.

You can view two frequencies at the same time by selecting dual Echosounder panels from the **Home** page.

Frequency is the 'tone' the transducer transmits. Transducers are designed to operate on different frequencies as the various frequencies have different qualities.

- A low frequency, for example 50 kHz, will go deep. It generates a wide cone but is somewhat more sensitive to noise. It is good for bottom discrimination and wide area search.
- A high frequency, for example 200 kHz, offers higher discrimination and is less sensitive to noise. It is good for separating targets and for higher speed vessels.

### Color and gain settings

Gain and Color control images are located in the left side of the Echosounder panel. You activate the control by tapping the image or by pressing the rotary knob on a remote controller. Active control expands and displays its name in full. You can then adjust the value by using the slide bar or by turning the rotary knob on the remote controller.

You can also adjust the image settings from the Echosounder menu.

### Gain

The gain controls the sensitivity of the Echosounder.

The more you increase the gain, the more details are shown on the image. However, a higher gain setting may introduce more background clutter on the image. If the gain is set too low, weak echoes might not be displayed.

### Auto gain

The Auto gain option keeps the sensitivity at a level that works well under most conditions.



With the gain in auto mode, you can set a positive or negative offset that gets applied to the auto gain.

### Color

Strong and weak echo signals have different colors to indicate the different signal strengths. The colors used depend on which palette you select.

The more you increase the Color setting, the more echoes is displayed in the color at the strong return end of the scale.

### Structure options

When a StructureScan source is connected to your system, you can overlay a DownScan image on the regular echo image.

For more information see "*Echosounder settings*" on page 88.

### Source

Select to specify the source for the image in the selected panel.

You can display two different sources simultaneously, using a split panel configuration. Menu controls for each panel are independent.

The source can be the internal Echosounder, another MFD on the Ethernet network, or a Echosounder module. To define sources, refer to the separate NSO evo3 Installation manual.

→ **Note:** Using two transducers at the same frequency ranges can cause interference between the two, and they can show up on the image as vertical lines. To avoid this, set one transducer at one frequency range (such as Medium CHIRP) and the other transducer at a different frequency range (such as High CHIRP) using the Frequency menu option.

### Pausing the image

You can pause the image, allowing you to examine it.

This function is useful when you need to position a waypoint exactly on the image, and if you are using the cursor to measure a distance between 2 elements on the image.

The pause function stops the Echosounder from pinging the transducer. The system is not collecting Echosounder data when paused in this manner.

## Advanced options

The Advanced option is only available when the cursor is not active.

### Noise rejection

Signal interference from bilge pumps, engine vibration and air bubbles can clutter the image.

The noise rejection option filters the signal interference and reduces the on-screen clutter.

### TVG

Wave action and boat wakes can cause onscreen clutter near the surface. The TVG (Time Variable Gain) option reduces surface clutter by decreasing the sensitivity of the receiver near the surface.

→ **Note:** For optimal image return and clarity in most conditions, the default value is set to 3, the maximum (range is 0-3).

### Scroll speed

You can select the scrolling speed of the image on the screen. A high scroll speed updates the image fast, while a low scroll speed presents a longer history.

→ **Note:** In certain conditions it may be necessary to adjust the scroll speed to get a more useful image. Such as adjusting the image to a faster speed when vertically fishing without moving.

## Ping speed

Ping speed controls the rate the transducer transmits the signal into the water. By default, the ping speed is set to max. It may be necessary to adjust the ping speed to limit interference or to adjust for specific fishing conditions.

## Start recording log data

You can start recording log data and save the file internally in the unit, or save it onto a storage device connected to the unit.

The record function is activated from the **Advanced** menu option.

When the data is being recorded, there is a flashing red symbol in the top left corner and a message appears periodically at the bottom of the screen.

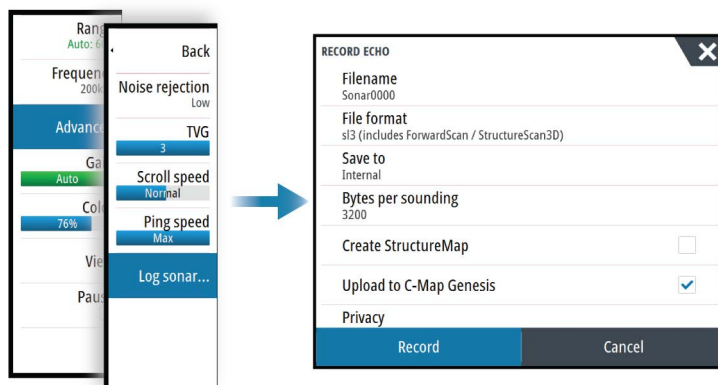

### Filename

Specify the name of the recording (log).

### File format

Select a file format from the drop-down, slg (Echosounder only), xtf (Structure only\*), sl2 (Echosounder and Structure) or sl3 (includes StructureScan 3D).

→ **Note:** XTF format is for use only with select 3rd party Echosounder viewing tools.

### Save to

Select whether the recording is to be saved internally or to a storage device connected to the unit.

### Bytes per sounding

Select how many bytes per sounding that are to be used when saving the log file. More bytes yield better resolution, but cause the record file to increase in size compared to using lower byte settings.

### Create StructureMap

If StructureScan is available on the network, you can convert the .sl2 or .sl3 logs to StructureMap format (.smf) when recording completes. The log file can also be converted to StructureMap format from the Files option.

### Upload to C-MAP Genesis

Files are transmitted to C-MAP Genesis when recording completes, if you are connected to a wireless hotspot. For information about wireless hotspots, refer to *"Wireless connection"* on page 102.

## Privacy

If allowed by your selected C-MAP Genesis account, you can choose between setting the recorded log files as Private or Public at C-MAP Genesis.

## Time remaining

Shows the remaining allocated space available for recordings.

## Stop recording log data

Select **Stop** in the Recording Echo dialog to fully stop the recording of all echosounder data.

→ **Note:** If you have selected the Upload to C-MAP Genesis option and are connected to a wireless hotspot, your recorded files are transmitted to C-MAP Genesis when you select Stop.

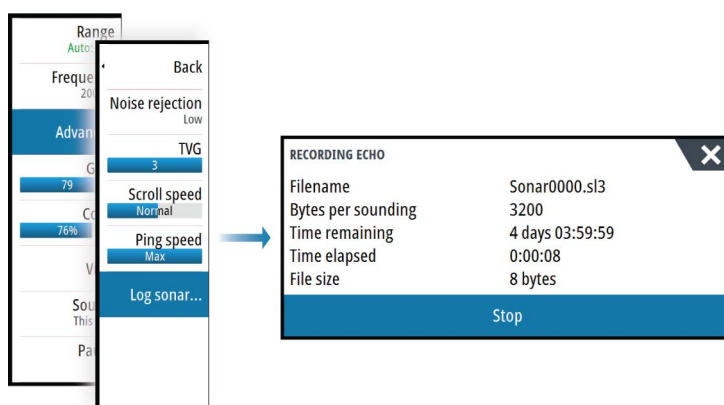

## Viewing the recorded sounder data

Both internally and externally stored sounder records may be reviewed when the view sonar log option is selected in the Echo settings dialog. Refer to *"Echosounder settings"* on page 88.

The log file is displayed as a paused image, and you control the scrolling and display from the replay menu option.

You can use the cursor on the replay image, and pan the image as on a normal echo image.

If more than one channel was recorded in the selected echo file, you can select which channel to display.

You exit the replay mode by selecting the **X** symbol in the upper right corner of the replay image.

## Echosounder View options

### Split screen options

#### Zoom

The Zoom mode presents a magnified view of the sounder image on the left side of the panel.

By default the zoom level is set to 2x. You can select up to 8x zoom from the drop-down menu or the zoom (+ or -) buttons.

The range zoom bars on the right side of the display shows the range that is magnified. If you increase the zooming factor the range is reduced. You see this as reduced distance between the zoom bars.

#### Bottom lock

The bottom lock mode is useful when you want to view echoes close to the bottom. In this mode, the left side of the panel shows an image where the bottom is flattened. The range scale is changed to measure from the seabed (0) and upwards. The bottom and the zero line

are always shown on the left image, independent of the range scale. The scaling factor for the image on the left side of the panel is adjusted as described for the Zoom option.

### Palettes

You can select between several display palettes optimized for a variety of fishing conditions.

### Temperature graph

The temperature graph is used to illustrate changes in water temperature.

When toggled on, a colored line and temperature digits are shown on the Echosounder image.

### Depth line

A depth line can be added to the bottom surface to make it easier to distinguish the bottom from fish and structures.

### A-Scope

The A-scope is a display of real-time echoes as they appear on the panel. The strength of the actual echo is indicated by both width and color intensity.

### Zoom bars

The zoom bars shows the range that is magnified on a split panel with zoom views.

The range zoom bars on the right side of the display shows the range that is magnified and displayed on the left side. If you increase the zooming factor, the range is reduced. You see this as reduced distance between the zoom bars.

You can move the zoom bars on the right side up or down to cause the left side image to show different depths of the water column.

### Fish ID

You can select how you want the echoes to appear on the screen. You can also select if you want to be notified by a beep when a fish ID appears on the panel.

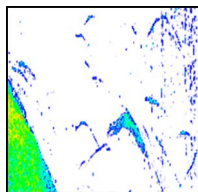

*Traditional fish echoes*

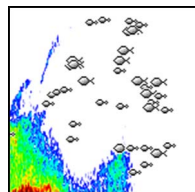

*Fish symbols*

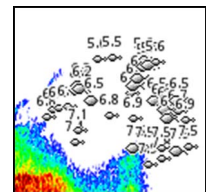

*Fish symbols and depth indication*

→ **Note:** Not all fish symbols are actual fish.

## Echosounder settings

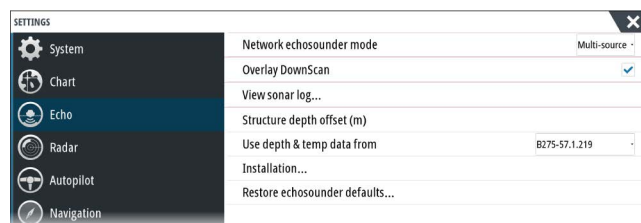

### Network echosounder mode

The network echosounder mode setting selects whether only one or multiple echosounder sources can be selected at the same time.

→ **Note:** Changing the mode requires that all connected sources are restarted.

## Overlay downscan

When a DownScan capable transducer is connected to your system, you can overlay DownScan images on the regular Echosounder image.

When overlay downscan is activated, the Echosounder panel menu expands to include basic DownScan options.

## View Echosounder log

Used to view Echosounder recordings. The log file is displayed as a paused image, and you control the scrolling and display from the menu.

You can use the cursor on the image, measure distance, and set view options as on a live Echosounder image. If more than one channel was recorded in the selected Echosounder file, you can select which channel to display.

You exit the view function by selecting the **X** in the upper right corner.

## Structure depth offset

Setting for Structure transducers.

All transducers measure water depth from the transducer to the bottom. As a result, water depth readings do not account for the distance from the transducer to the lowest point of the boat in the water or from the transducer to the water surface.

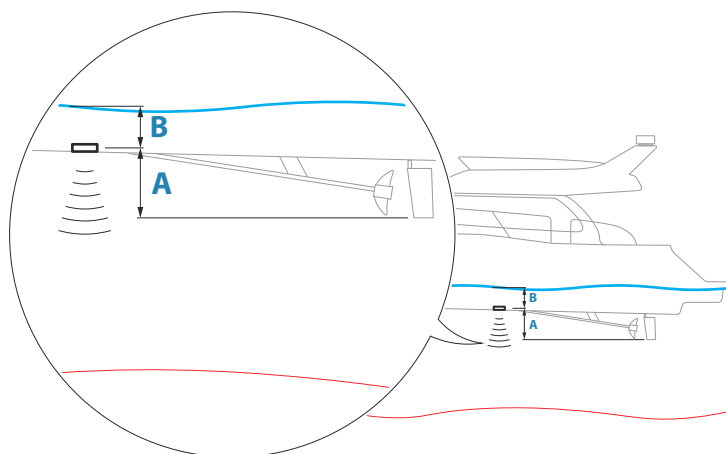

- To show the depth from the lowest point of the vessel to the bottom, set the offset equal to the vertical distance between the transducer and the lowest part of the vessel, **A** (negative value).
- To show the depth from the water surface to the bottom, set the offset equal to the vertical distance between the transducer and the water surface, **B** (positive value)
- For depth below transducer, set the offset to 0.

## Use depth and temp data from

Selects from which source the depth and temperature data is shared on the NMEA 2000 network.

## Installation

Used for installation and setup. See the separate Installation manual

## ForwardScan setup

Available when the ForwardScan feature is turned on. For setup information, refer to the Operator Manual.

# 11

## StructureScan

StructureScan uses high frequencies to provide a high resolution, picture-like image of the seabed.

→ **Note:** You must have a StructureScan HD, TotalScan or StructureScan 3D transducer installed to use StructureScan features.

StructureScan is not integrated in NSO evo3. You must have a compatible external StructureScan module available on the network to use the StructureScan features.

→ **Note:** StructureScan 3D is also supported. StructureScan 3D is a sonar technology that allows anglers to see underwater structure and bottom contours in customizable, three-dimensional views. For more information about StructureScan 3D, refer to the separate StructureScan 3D documentation.

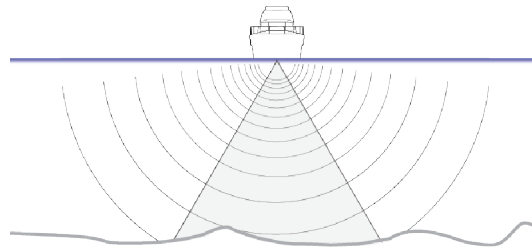

### The StructureScan image

#### The view

The StructureScan panel can be set up as a DownScan image, or showing left/right side scanning.

The DownScan image can also be added as an overlay to the traditional Echosounder image.

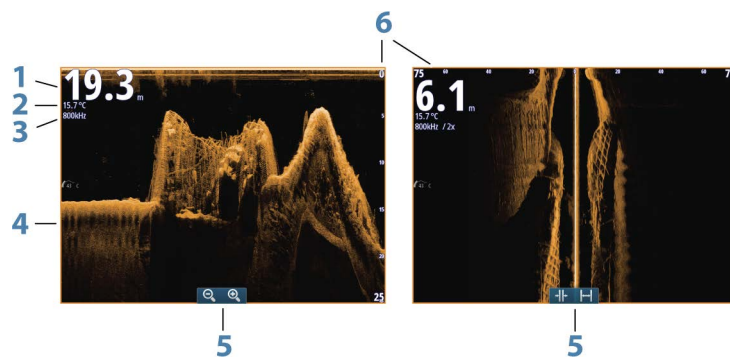

1 Depth

→ **Note:** The depth reading depends on the **Structure depth offset** setting, refer to "Structure depth offset" on page 89.

2 Temperature

3 Frequency

4 Bottom

5 Zoom (downscan) / Range (sidescan) icons

6 Range scale

### Zooming the StructureScan image

You can zoom a StructureScan image by:

- Touch operation: using the panel zoom icons, or by pinching or spreading on the screen

- Key operation: using the +/- keys
- Remote controller operation: turning the rotary knob when the cursor is not active, or by using the **IN/OUT** keys

Zoom level is shown on the upper left side of the panel.

## Using the cursor on the StructureScan panel

By default, the cursor is not shown on the StructureScan image.

When you position the cursor on a DownScan image, the screen pauses, the cursor information window and the history bar are activated. On a DownScan image, the depth is shown at cursor position.

When you position the cursor on a SideScan image, the screen pauses, and the cursor information window is activated. On a SideScan image, the left/right distance from the vessel to the cursor are shown at the cursor position.

### GoTo cursor

You can navigate to a selected position on the image by positioning the cursor on the panel, then using the **Goto Cursor** option in the menu.

### The cursor assist function

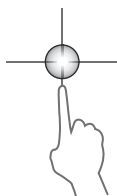

→ **Note:** The cursor assist function is available if it is enabled. Refer to "*Customizing the long press feature*" on page 20.

The cursor assist function allows for fine tuning and precision placement of the cursor without covering details with your finger.

Activate the cursor on the panel, then press and hold your finger on the screen to switch the cursor symbol to a selection circle, appearing above your finger.

Without removing your finger from the screen, drag the selection circle to the desired position.

When you remove your finger from the screen the cursor reverts to normal cursor operation.

### Measuring distance

The cursor can be used to measure the distance between the position of two observations on the image.

1. Position the cursor on the point from where you want to measure the distance
2. Start the measuring function from the menu
3. Position the cursor on the second measuring point
  - A line is drawn between the measuring points, and the distance is listed in the Cursor Information panel
4. Continue selecting new measuring points if required

You can use the menu to re-position the start point and the end point as long as the measuring function is active.

When you select **Finish measuring**, the image resumes to normal scrolling.

## Viewing StructureScan history

Whenever the cursor is active on a StructureScan panel, the scroll bar is shown on the panel. The scroll bar shows the image you are currently viewing in relation to the total StructureScan image history stored. Depending on the view selected, the scroll bar is on the far right side (SideScan) or at the top of the screen (DownScan).

You can pan the image history by dragging up/down (SideScan) or left/right (DownScan).

To resume normal StructureScan scrolling, press **Clear cursor**.

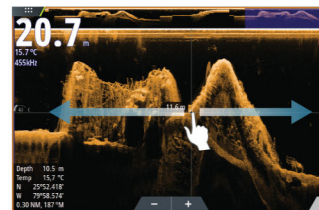
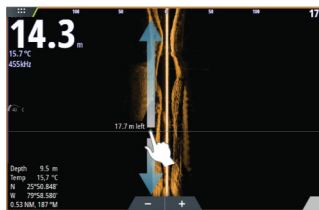

## Setting up the StructureScan image

### Range

The range setting determines the water depth and SideScan range that is visible on the screen.

#### Auto range

When the range is set to Auto the system automatically sets the range depending on the water depth.

#### Preset range levels

You can select between several preset range levels.

#### Custom range

This option allows you to manually set both upper and lower range limits.

### StructureScan frequencies

StructureScan supports two frequencies. 455 kHz provides ideal range and image quality in most situations, while 800kHz is used to provide higher detail in shallow water.

### Contrast

Determines the brightness ratio between light and dark areas of the screen.

To adjust the contrast setting:

1. Select the contrast icon or activate the contrast option in the menu to display the color adjustment bar
2. Drag the bar or use the rotary knob to set the value.

### Palettes

You can select between several display palettes optimized for a variety of fishing conditions.

### View

You can set up the StructureScan page as a DownScan image, left only, right only, or left/right side scanning.

### Pausing the StructureScan image

You can pause the StructureScan image, allowing you to examine the structures and other images in more depth and detail.

This function is useful when you need to position a waypoint exactly on the StructureScan image, and if you are using the cursor to measure a distance between 2 elements on the image.

## Advanced StructureScan settings

### TVG

Wave action and boat wakes can cause onscreen clutter near the surface. The TVG (Time Variable Gain) option reduces surface clutter by decreasing the sensitivity of the receiver near the surface.



→ **Note:** For optimal image return and clarity in most conditions, the default value is set to 3, the maximum (range is 0-3).

### **Flipping the Structure image left/right**

If required, the left/right SideScanning images can be flipped to match the direction of the transducer installation.

### **Range Lines**

Range lines can be added to the image to make it easier to estimate depth (Downscan) and distance (SideScan).

### **Recording StructureScan data**

You can record StructureScan data and save the file internally in the unit, or onto a storage device connected to the unit as described in "*Start Recording echosounder data*" on page 86.

# 12

## StructureMap

The StructureMap feature overlays SideScan images from a StructureScan source on the map. This makes it easier to visualize the underwater environment in relation to your position, and aids in interpreting SideScan images.

### The StructureMap image

The example below shows a chart panel with Structure overlay, combined with a traditional SideScan panel.

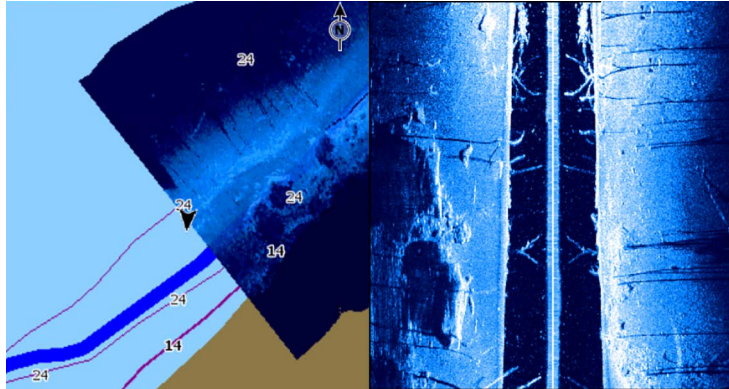

You move around in the chart as usual when you have a Structure overlay:

- Touch operation: zoom the chart and the scanned image by using the zoom (+ or -) buttons, or by pinching or spreading on the screen. Drag on the panel to view the scanned image.
- Key operation: zoom the chart and the scanned image by using the +/- keys.
- Remote controller operation: zoom the chart and the scanned image by turning the rotary knob, by using the zoom icons or the **IN/OUT** keys. Move the chart to view the scanned image by using the arrow keys

Selecting the **Clear cursor** option removes the cursor from the panel, and the chart center is positioned at the vessel.

### Activating Structure overlay

1. Turn on Structure overlay from the chart menu
    - The chart menu is increased to show Structure options
    - Structure data starts to appear on the chart screen as soon as Structure overlay is enabled
  2. Select Structure source
    - Live data is default
- **Note:** Structure overlay can also be activated by selecting a saved StructureMap file in the files browser.

### StructureMap sources

Two sources can be used to overlay Structure logs on the charts, but only one can be viewed at a time:

- Live data - Used when StructureScan data is available on the system.
- Saved files - These are recorded StructureScan (\*.sl2 or \*.sl3) data that are converted to StructureMap (\*.smf) format. Saved \*.smf files can be used even if no StructureScan sources are connected.

#### Live source

When live data is selected, the SideScan imaging history is displayed as a trail behind the vessel icon. The length of this trail varies depending on available memory in the unit and range settings. As the memory fills up, the oldest data is automatically deleted as new data is

added. When increasing the search range, the ping speed of the StructureScan transducer is reduced, but the width and the length of the image history is increased.

→ **Note:** Live mode does not save any data. If the unit is turned off, all recent data is lost.

### Saved files

When Saved files are selected, the StructureMap file is overlaid on the map based on position information in the file.

If the chart scale is large, the StructureMap area is indicated with a boundary box until the scale is large enough to show Structure details.

Saved mode is used to review and examine StructureMap files, and to position the vessel on specific points of interest on a previous scanned area.

→ **Note:** When saved files are used as the source, all StructureMap files found on the storage device and in the system's internal memory are displayed. If there is more than one StructureMap of the same area, the images overlap and clutter the chart. If several logs of the same area are required, the maps should be put on separate storage devices.

## StructureMap tips

- To get a picture of taller structures (a wreck, etc.) — do not drive over it, instead, steer the boat so the structure is on the left or right side of your vessel.
- Do not overlap history trails when conducting a side-by-side scan of an area.

## Recording StructureScan data

StructureScan data can be recorded from a chart panel with Structure overlay enabled.

StructureScan recordings can also be started from a StructureScan panel.

When StructureScan data is being recorded, there is a flashing red symbol and a message appears periodically at the bottom of the screen.

→ **Note:** The message includes information about file size. Keep the size of your logs to 100MB or less to allow for faster file conversion.

The recording is stopped by re-selecting the record function.

### Converting StructureScan data to StructureMap format

A StructureScan log file (.sl2) is converted to StructureMap format (.smf) after recording from the recording dialog, or from the files browser.

You can create standard or high resolution files. High resolution .smf files capture more detail, but take longer to convert and are larger than standard resolution files.

To save disc space it is recommended to remove the StructureScan (.sl2) files after conversion.

## Using StructureMap with mapping cards

StructureMap allows you to maintain full chart capability and can be used with preloaded cartography as well as C-MAP, Navionics, and other third-party charting cards compatible with the system.

When using StructureMap with mapping cards, copy the StructureMap (.smf) files to the unit's internal memory. We recommend keeping copies of StructureMap files on external mapping cards.

## Structure options

You adjust the StructureMap settings from the Structure options menu. The menu is available when Structure overlay is enabled.

Not all options are available when saved StructureMap files are used as the source. Unavailable options are greyed.

### Range

Sets the search range.

**Transparency**

Sets the opaqueness of the Structure overlay. With minimum transparency settings, the chart details are almost hidden by the StructureMap overlay.

**Palette**

Selects Structure palette.

**Contrast**

Determines the brightness ratio between light and dark areas of the screen.

**Water column**

Shows/hides the water column in Live mode.

If turned OFF schools of bait fish might not be seen on the SideScan image.

If turned ON the accuracy of the SideScan image on the map might be affected by the water depth.

**Frequency**

Sets the transducer frequency used by the unit. 800 kHz offers the best resolution, while 455 kHz has greater depth and range coverage.

**Noise rejection**

Signal interference from bilge pumps, engine vibration and air bubbles can clutter the sonar screen. The noise rejection option filters the signal interference and reduces on-screen clutter.

**Clear live history**

Clears existing live history data from the screen and begins showing only the most current data.

**Record data**

Records StructureScan data.

**Source**

Selects StructureMap source.

# 13

## ForwardScan

ForwardScan sonar is a navigational aid that helps you monitor the underwater environment in front of your vessel while carrying out slow speed maneuvers.

To use the ForwardScan feature you must have a ForwardScan transducer mounted on your vessel.

The ForwardScan transducer must be connected to a compatible sonar module (or another unit which have built-in sonar shared over the network).

→ **Note:** If you have both a sonar/CHIRP and a ForwardScan transducer connected to different sonar modules (or another unit which have built-in sonar shared over the network), you can view both simultaneously on a single device.

⚠ **Warning:** Do not rely on this equipment as your principle source of navigation or hazard detection.

⚠ **Warning:** Do not use this equipment to gauge depth or other conditions for swimming or diving.

### The ForwardScan image

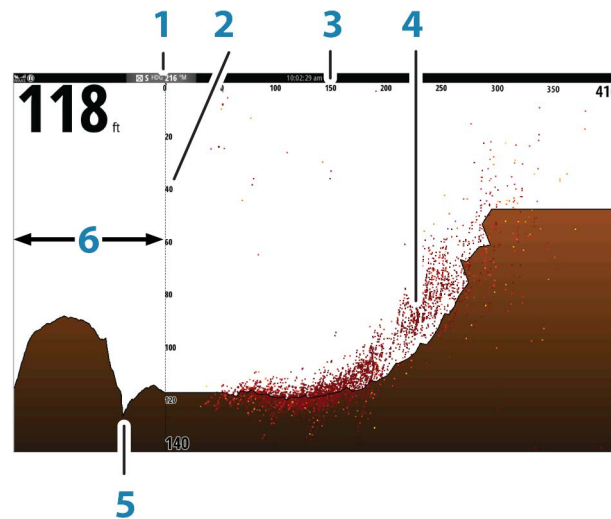

- 1 Transducer location shown as the origin on the page
- 2 Depth range scale and vessel position
- 3 Forward range scale
- 4 Point data
- 5 Bottom
- 6 Depth history

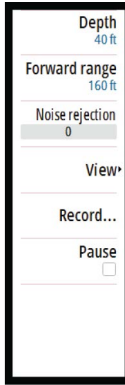

## Setting up the ForwardScan image

### Depth

Controls depth range. Depth range is set to auto mode by default.

### Forward range

Controls the forward looking search range. Maximum Forward range is 91 meters (300 feet).

### Noise Rejection

Filters out signal interference and reduces on-screen clutter.

### Record

Records ForwardScan sonar logs.

### Pause

Pauses forward-looking Echosounder transmissions.

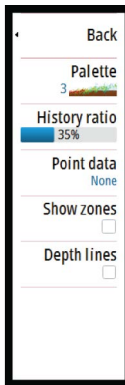

## ForwardScan view options

### Palette

Several display palettes are available for a variety of water conditions.

### History ratio

Controls how much Echosounder history is shown behind the boat. The higher the ratio, the more history will be shown.

### Point data

By default, ForwardScan only shows the bottom. Select the Point data menu option to specify to view no sonar data points, all sonar data points, or only points (Objects) in the water column.

### Show zones

Displays warning zones (yellow) and critical zones (red) on the screen. Refer to "*Critical forward range and Critical depth*" on page 99.

### Depth lines

Displays lines on the screen that make it easier to quickly estimate depth and the underwater objects.

## Heading extension

You can use the heading extension to monitor ForwardScan on the chart panel. Heading extension colors are based on the ForwardScan alarm values.

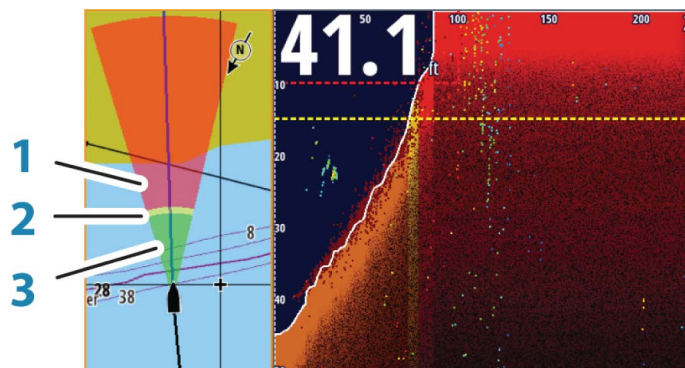

## ForwardScan extension

- 1 Red - Critical
- 2 Yellow - Warning
- 3 Green - Safe

Select ForwardScan in the Chart Settings dialog to view the ForwardScan heading extension on the chart panel.

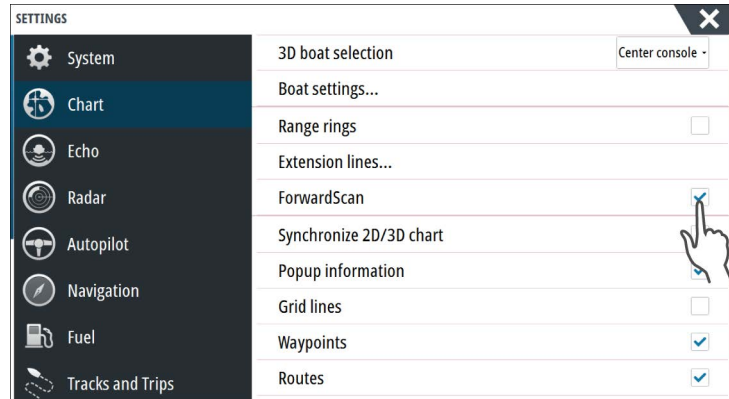

## ForwardScan setup

Specify the setup in the **ForwardScan installation** dialog.

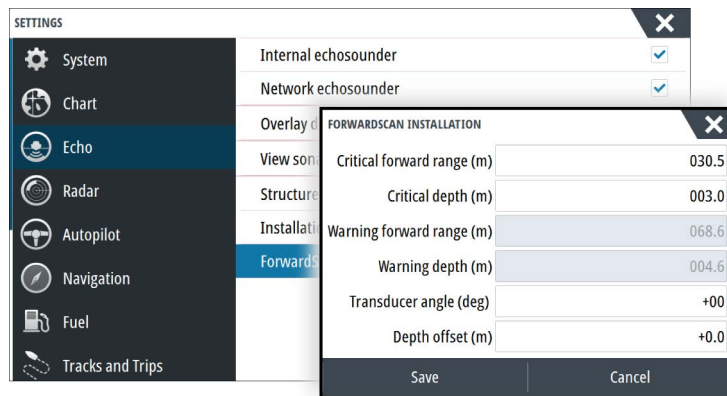

## Critical forward range and Critical depth

Critical Forward Range and Critical Depth are user-selected thresholds that define a critical zone forward of your vessel.

If you travel into water shallow enough to cross into the critical zone, the Critical Zone alarm is activated. You can display the critical warning zones by activating the **Show zones** menu option.

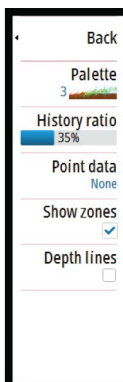

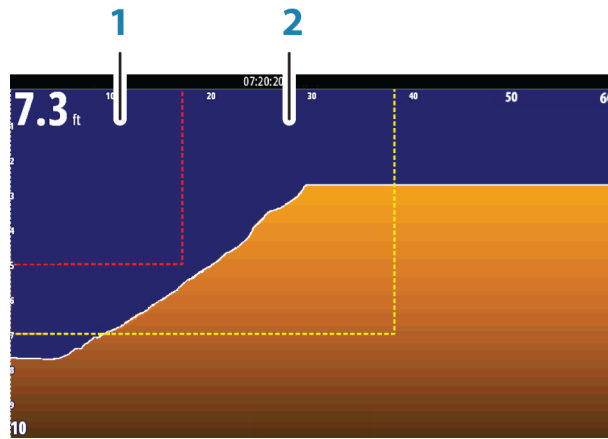

ForwardScan image with Show zones active

- 1 Critical zone
- 2 Warning zone

Warning Forward Range and Warning Depth values are based on the selected Critical Forward Range and Critical Depth values.

→ **Note:** To receive Critical Zone alerts, enable ForwardScan alarm in the Alarm settings dialog. For more information about enabling alarms, refer to Alarms.

### Transducer angle

We recommend installing the transducer vertical to the waterline. In cases where that is not possible, the Transducer Angle setting helps offset the difference between the transducer angle and the waterline.

The angle can be adjusted from 0 (vertical) to 20 degrees.

**Warning:** Adjustments to the transducer angle value should be done with caution. Large variations in the transducer angle value can distort depth data, increasing the risk of striking underwater obstructions.

### Depth offset

Setting for ForwardScan transducers.

All transducers measure water depth from the transducer to the bottom. As a result, water depth readings do not account for the distance from the transducer to the lowest point of the boat in the water or from the transducer to the water surface.

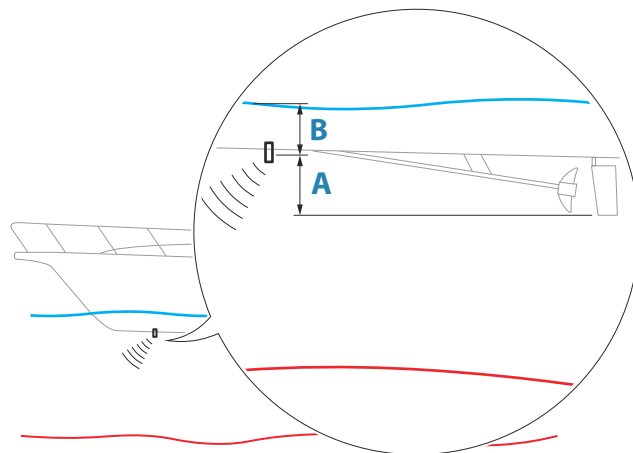

- To show the depth from the lowest point of the vessel to the bottom, set the offset equal to the vertical distance between the transducer and the lowest part of the vessel, **A** (negative value).



- To show the depth from the water surface to the bottom, set the offset equal to the vertical distance between the transducer and the water surface, **B** (positive value)
- For depth below transducer, set the offset to 0.

# 14

## Wireless connection

Wireless connectivity gives you the ability to:

- Use a wireless device to remotely view (smartphone and tablet) and control the system (tablet only).
- Access the GoFree Shop.
- Upload your Echosounder logs to create custom maps at C-MAP Genesis.
- Download software updates
- Connect to third party applications

→ **Note:** Maps, charts, software updates, and other data files can be large. Your data provider may charge you based on the amount of data you transfer. If you are unsure contact the service provider for information.

The unit includes Built-in wireless functionality for connecting to the internet and wireless devices such as smartphones and tablets.

Initial configuration and setup of the built-in wireless functionality is described in your system's Installation Manual.

→ **Note:** To use the built-in wireless, it must be enabled. Refer to "*Internal Wireless*" on page 104.

### Connect and disconnect from a wireless hotspot

To connect to a wireless hotspot, select the Wireless option in the System Controls dialog and then select Not Connected. This opens the Wireless Devices dialog. Use this dialog to select the desired hotspot, enter the login information and then select Connect. Connecting to a wireless hotspot changes the wireless mode to **Client mode**. In this mode, you can access the internet.

To disconnect from a wireless hotspot, select the Wireless option in the System Controls dialog, then select Connected *hotspot\_name*, and then Disconnect. This changes the wireless mode to **Access point mode**. In this mode, you can connect a wireless device so that Apps such as GoFree Link can access the vessel's navigation information.



### GoFree Shop

The wireless must be connected to an external wireless hotspot in order to access the GoFree Shop.

At the GoFree Shop you can browse, purchase and download compatible content for your system including navigation charts and C-MAP Genesis maps.

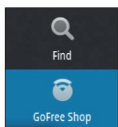

### GoFree Link

The wireless functionality lets you use a wireless device to remotely view (smartphone and tablet) and control the system (tablet only). The system is viewed and controlled from the wireless device by the GoFree Link Apps downloaded from their relevant Application store. When remote control is accepted, the active page is mirrored to the wireless device.

→ **Note:** To use smartphones and tablets to view and control the system, wireless functionality must be disconnected from the wireless hotspot (in **Access point mode**).

→ **Note:** For safety reasons, Autopilot and CZone functions cannot be controlled from a wireless device.



### Connecting a tablet

Install the GoFree App on the tablet before following this procedure.

1. Set the internal wireless to **Access Point** mode. To do this, select the **Wireless devices** page in the Wireless settings dialog and then select the Internal wireless. Next, select the **Mode** option and then select **Internal Access Point**.
2. Select a device on the **Wireless devices** page to view its network key.
3. Navigate to the wireless network connection page on the tablet, and find the unit or GoFree wireless *xxxx* network. If more than one is in range, review the **Wireless devices** page on the unit to confirm which wireless device is connected to the unit.

4. Enter the Network Key in the tablet to connect to the network.
5. Open the GoFree application - the unit should be automatically detected. The name displayed will be either the default, or that assigned in the Device Name setting. If the unit does not appear, follow the on screen instructions to manually find the device.
6. Select the graphic icon of the unit. The unit displays a prompt similar to the following:

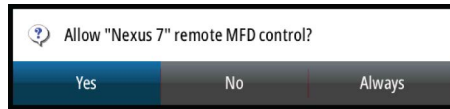

7. Select **Yes** for one-time connection, or **Always** if device is to be remembered for regular connection. This setting can be changed later if required.
- **Note:** The internal wireless module only supports GoFree connection to itself. Other units connected on the network are not visible.

### Connecting a smartphone

Install the GoFree App on the smartphone before following this procedure.

1. Set the internal wireless to **Access Point** mode. To do this, select the **Wireless devices** page in the Wireless settings dialog and then select the unit's Internal Wireless. Next, select the **Mode** option and then select **Internal Access Point**.
2. Select a device on the **Wireless devices** page to view its Network Key.
3. Navigate to the wireless network connection page on the smartphone, and find the unit or GoFree wireless **xxxx** network. If more than one is in range, review the **Wireless devices** page from the unit's Wireless settings dialog to confirm which wireless device is connected to the unit.
4. Enter the Network Key in the smartphone to connect to the network.
5. Open the GoFree application on the smartphone, the unit should be automatically detected. The name displayed will be either the default, or that assigned in the Device Name setting. If the unit does not appear, follow the on screen instructions to manually find the device.

The MFD's display is shown on the smartphone. To change the MFD's display on the smartphone, use the MFD to change the display on the MFD. The display change on the MFD is reflected on the smartphone.

### Uploading log files to C-MAP Genesis

To upload a recorded Echosounder log file to C-MAP Genesis, select the file you want to upload from the Files panel and select the upload to C-MAP Genesis option.

- **Note:** You must be connected to a wireless hotspot to upload recorded log files to C-MAP Genesis.
- **Note:** Recorded log files can also be uploaded to C-MAP Genesis if you have specified **Upload to C-MAP Genesis** in the Record Echo dialog. For more information, refer to *"Start Recording log data"* on page 86.

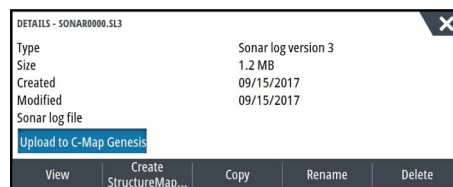

### Wireless settings

Provides configuration and setup options for the wireless functionality. For more information, refer to the NSO evo3 Installation Manual.

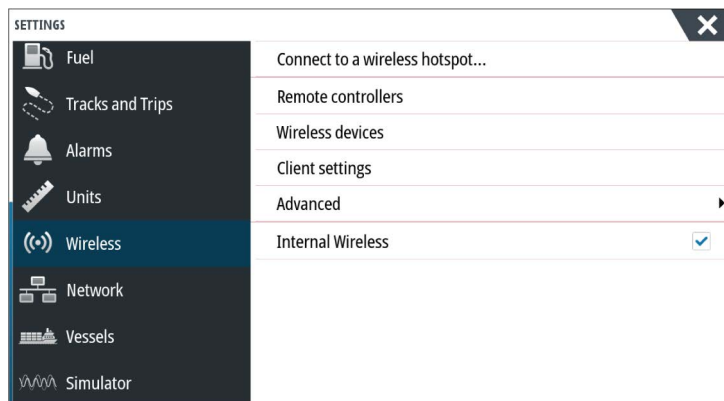

### Connect to a wireless hotspot

Displays the Wireless device dialog that you can use to connect the wireless functionality to a wireless hotspot.

### Remote controllers

When a wireless device (smart phone or tablet) is connected, it should appear in the Remote controllers list. Selecting **Always allow** means the device can automatically connect without needing a password each time. This menu also allows you to disconnect devices that no longer require access.

### Wireless devices

This dialog shows the internal wireless and any connected WIFI-1 devices, as well as their IP and channel number. Selecting the internal wireless or a WIFI-1 device provides additional detail.

To view and change internal wireless detail values (Network Name (SSID), Network Key, or Channel) the internal wireless must be in **Access Point** (Internal Wifi) mode. To select a network (hotspot) to connect to, the internal wireless must be in **Client Mode**. Use the Mode option to change modes.

### Client settings

Displays information about the wireless hotspot your unit is connected to or the last one your unit was connected to. You can select the hotspot in the dialog to set it as a hotspot you want to always connect to when in range or you can select to delete it.

### Advanced

Initiates the Iperf and DHCP Probe tools that help in fault-finding and setting up the wireless network.

→ **Note:** Iperf and DHCP Probe are tools provided for diagnostic purposes by users familiar with network terminology and configuration. Navico is not the original developer of these tools, and does not provide support related to their use.

### Internal Wireless

Select this option to enable or disable the internal wireless module.  
Disabling wireless when not in use reduces the unit's power consumption.

# 15

## AIS

If a compatible AIS (Automatic Identification System) source is connected to the system, then any targets detected by these devices can be displayed and tracked. You can also see messages and position for DSC transmitting devices within range.

AIS targets can be displayed as overlay on radar and chart images, making this feature an important tool for safe travelling and collision avoidance.

You can set alarms to notify you if an AIS target gets too close or if the target is lost.

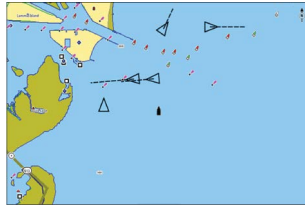



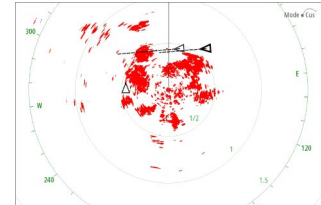



AIS vessels on a chart panel



AIS vessels on a radar panel

### AIS target symbols

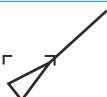
The system uses the AIS target symbols shown below:

	Sleeping AIS target (not moving or at anchor).
	Moving and safe AIS target with course extension line.
	Dangerous AIS target, illustrated with bold line. A target is defined as dangerous based on the CPA and TCPA settings. Refer to <i>"Defining dangerous vessels"</i> on page 109.
	Lost AIS target. When no signals have been received within a time limit, a target is defined as lost. The target symbol represents the last valid position of the target before the reception of data was lost.
	Selected AIS target, activated by selecting a target symbol. The target returns to the default target symbol when the cursor is removed from the symbol.
	AIS SART (AIS Search And Rescue Transmitter).

### Viewing information about AIS targets

#### Searching for AIS items

You can search for AIS targets by using the **Find** option in the Tools panel.

From a chart panel you can search for AIS targets by using the **Find** option in the menu. If the cursor is active, the system searches for vessels around the cursor position. Without an active cursor, the system searches for vessels around your vessel's position.

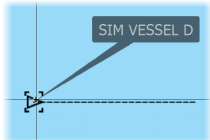
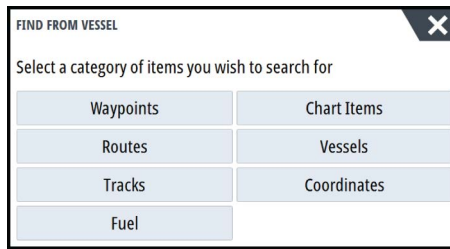

## Viewing information about single AIS targets

When you select an AIS icon on the chart or radar panel the symbol changes to Selected target symbol, and the vessel's name is displayed.

You can display detailed information for a target by selecting the AIS pop-up, or from the menu when the target is selected.

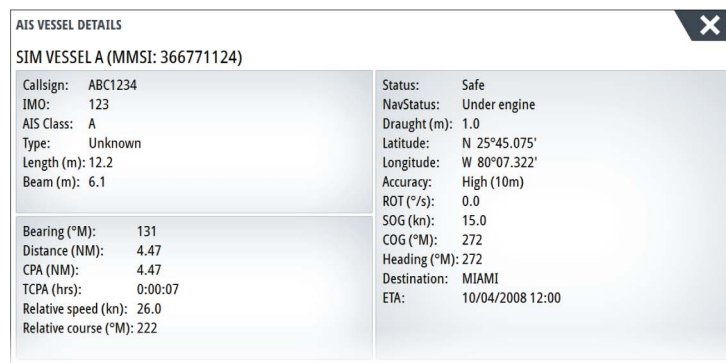

## AIS information on radar panels

The radar data bar includes information on up to 3 AIS targets.

The targets are listed with the closest target on top, and are color coded to indicate target status.

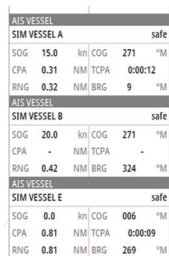

## Calling an AIS vessel

If the system includes a VHF radio supporting DSC (Digital Select Calling) calls over NMEA 2000, you can initiate a DSC call to other vessels from the NSO evo3.

The call option is available in the **AIS Vessel Details** dialog, and in the **Vessel** status dialog activated from the **Tools** panel.

From the **Call** dialog you can change channel or cancel the call. The **Call** dialog is closed when the connection is established.

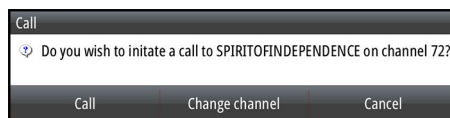

## AIS SART

When an AIS SART (Search and Rescue beacon) is activated, it starts transmitting its position and identification data. This data is received by your AIS device.

If your AIS receiver is not compliant with AIS SART, it interprets the received AIS SART data as a signal from a standard AIS transmitter. An icon is positioned on the chart, but this icon is an AIS vessel icon.

If your AIS receiver is compliant with AIS SART, the following takes place when AIS SART data is received:



- An AIS SART icon is located on the chart in the position received from the AIS SART
- An alarm message is displayed

If you have enabled the siren, the alarm message is followed by an audible alarm.

→ **Note:** The icon is green if the received AIS SART data is a test and not an active message.

### AIS SART alarm message

When data is received from an AIS SART, an alarm message is displayed. This message includes the AIS SART's unique MMSI number, and its position, distance, and bearing from your vessel.

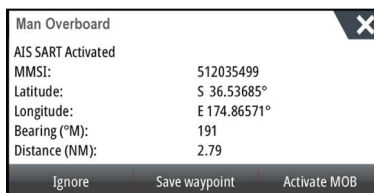

You have the following options:

- Ignore the alarm
  - The alarm is muted and the message closed. The alarm does not reappear
- **Note:** If you ignore the alarm, the AIS SART icon remains visible on your chart, and the AIS SART remains in the Vessels list.
- Save the waypoint
  - The waypoint is saved to your waypoint list. This waypoint name is prefixed with MOB AIS SART - followed by the unique MMSI number of the SART. For example, MOB AIS SART - 12345678.
- Activate the MOB function
  - The display switches to a zoomed chart panel, centered on the AIS SART position
  - The system creates an active route to the AIS SART position
- **Note:** If the MOB function is already active, this will be terminated and replaced by the new route towards the AIS SART position!
- **Note:** If the AIS stops receiving the AIS SART message, the AIS SART remains in the Vessels list for 10 minutes after it receives the last signal.

If you select the AIS SART icon on the chart panel, then you can see the AIS MOB details.

### Vessel alarms

You can define several alarms to alert you if a target shows up within predefined range limits, or if a previously identified target is lost.

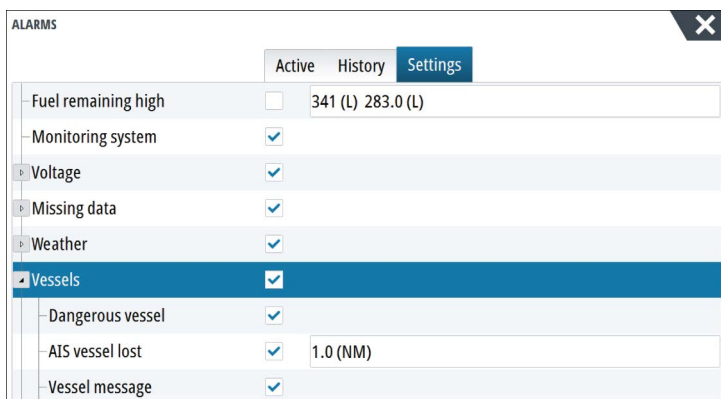
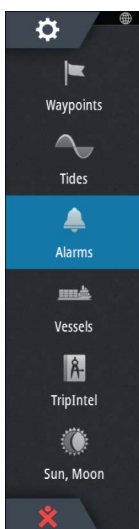

## Dangerous vessel

Controls whether an alarm will be activated when a vessel comes closer than the distance for CPA within the time limit for TCPA. Refer to *"Defining dangerous vessels"* on page 109.

## AIS vessel lost

Sets the range for lost vessels. If a vessel is lost within the set range, an alarm occurs.

→ **Note:** The check box controls whether the alarm pop-up box is displayed and if the siren goes on. The CPA and TCPA define when a vessel is dangerous regardless of the enabled or disabled state.

## Vessel message

Controls whether an alarm will be activated when a message is received from an AIS target.

## Vessel settings

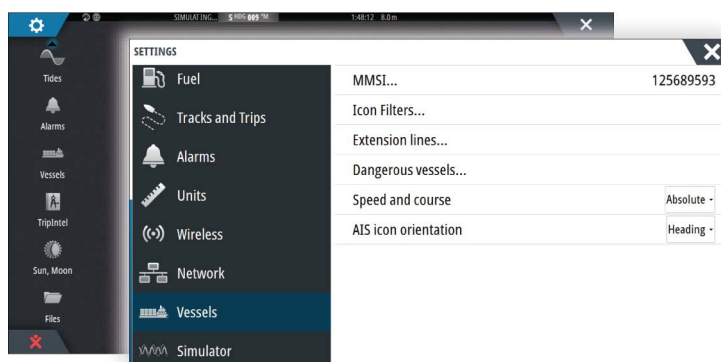

## Your vessel's MMSI number

Your vessel MMSI (Maritime Mobile Service Identity) number must be entered in the AIS transceiver to receive messages from AIS and DSC. You also need to have your MMSI number entered in the MFD to receive the messages in the MFD and to avoid seeing your own vessel as an AIS target on the chart.

→ **Note:** The Vessel message option in the alarm settings must be toggled on for any MMSI message to be displayed.

## Icon filters

By default, all targets are shown on the panel if an AIS device is connected to the system. You can select not to show any targets, or to filter the icons based on security settings, distance, and vessel speed.

→ **Note:** For security settings, refer to *"Defining dangerous vessels"* on page 109.

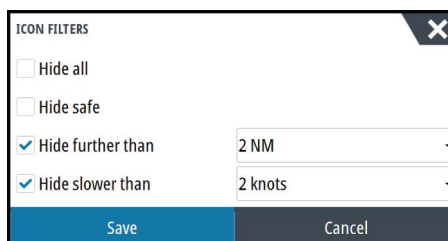



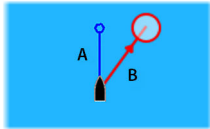

## Extension lines

The length of the extension lines for your vessel and for other vessels can be set by the user.

- A: Heading
- B: Course Over Ground (COG)

The length of the extension lines is either set as a fixed distance, or to indicate the distance the vessel will move in the selected time period. If no options are turned on for **This vessel** then no extension lines are shown for your vessel.

Your own vessel heading information is read from the active heading sensor, and COG information is received from the active GPS.

For other vessels COG data is included in the message received from the AIS system.

## Defining dangerous vessels

You can define an invisible guard zone around your vessel. When a target comes within the set limits, the symbol changes to the Dangerous target symbol. An alarm is triggered if activated in the Alarm settings panel.

## Speed and course indication

The extension line can be used to indicate speed and course for targets, either as absolute (true) motion in the chart or relative to your vessel.

A different line style is used on the extension lines to indicate motion, as shown below.



*AIS vessels shown with Absolute motion*



*AIS vessels shown with Relative motion*

## AIS icon orientation

Sets the orientation of the AIS icon, either based on heading or COG information.

# 16

## Instrument panels

The Instruments panels consist of multiple gauges - analog, digital and bar - that can be customized to display selected data. The Instruments panel displays data on dashboards, and you can define up to ten dashboards within the Instruments panel.

→ **Note:** To include fuel/engine information, engine and tank information has to be configured from the Settings panel.

### Dashboards

A set of dashboard styles are predefined to display vessel, navigation, angler and instrument information.

You switch between the panel's dashboards by selecting the left and right arrow buttons on the panel. You can also select the dashboard from the menu.



Vessel dashboard

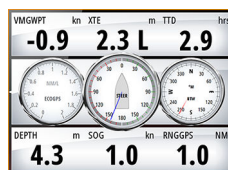

Navigation dashboard

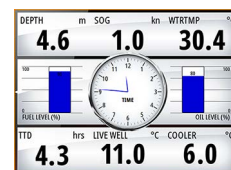

Angler dashboard

→ **Note:** Additional dashboards can be activated from the menu if other systems (e.g. CZone) are present on the network.

### Customizing the Instruments panel

You can customize the Instruments panel by changing the data for each of the gauges in the dashboard, by changing the dashboard layout, and by adding new dashboards. You can also set limits for analog gauges.

All edit options are available from the Instruments panel menu.

Available editing options depend on which data sources are connected to your system.

#### Edit a dashboard

Activate the dashboard you want to edit, then either press and hold on the gauge you want to change and select the information to be displayed or do the following:

1. Activate the menu
2. Select the edit option
3. Select the gauge you want to change. Selected gauge is indicated with a colored background
4. Select information to be displayed, configure limits, and eventually change the source for the information
5. Save your changes by selecting the save option in the menu

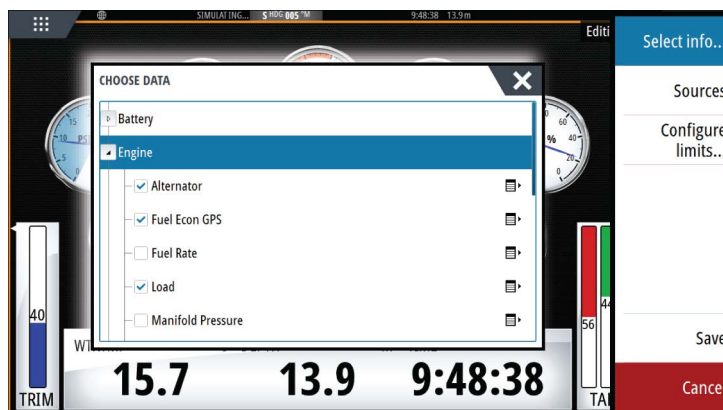
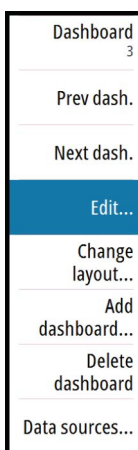

# 17

## Audio

If a compatible NMEA 2000 or Ethernet audio system is connected to the network, you can use the unit to control and customize the audio system on your vessel.

Before you can start using your audio equipment, it must be installed according to the unit's Installation manual and to the documentation included with the audio device.

### Enabling audio

A compatible audio device connected to the NMEA 2000 network should automatically be identified by the system. If not, enable the feature from the Advanced Settings dialog.

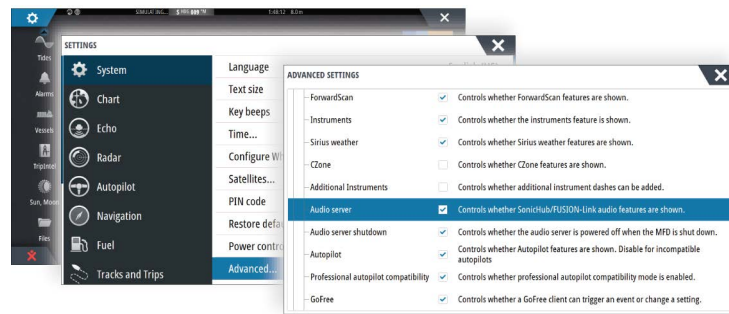

### Audio server

If multiple audio sources are connected to the same network, one of the devices must be selected as the Audio server. If only one of the devices is present, it is the selected Audio server by default.

### Operating the audio system

1. Select Audio in the Control bar to open the Audio controller
2. Select the Audio source button and then select the audio source
  - Number of sources depends on the active audio server
3. Use the controller buttons to control your audio system

For an overview of audio control buttons and tools, refer to *"Audio control buttons"* on page 112. Also see *"Audio Tools"* on page 112.

For available options, refer to the documentation following your audio equipment.

### The Audio controller

The control buttons, tools and options vary from one audio source to another.











- 1 Audio controller
- 2 Audio source



- 3 Audio controller buttons
- 4 Audio controller tools





### Audio control buttons

→ **Note:** VHF controls are available when audio servers with built in VHF receivers are connected.  
 The Mic source allows you to broadcast loud hailer messages over the audio system.

Icon	Tuner	VHF	DVD	Playback
	Select to display the list of available sources			
	Select to go to previous frequency. Press and hold to tune in a channel.		Select to rewind	Press and hold to rewind. Select to play previous track.
	Select to go to next frequency. Press and hold to tune in a channel.		Select to fast forward	Press and hold to fast forward. Select to play next track.
	Select to go to next/previous favorite channel		N/A	N/A
	N/A	N/A	Select to start	
	N/A	N/A	Select to pause playback	
	Select to display the volume slider.			
	Select to mute.			
	Select to unmute.			

### Audio tools

Icon	Tuner	VHF	Playback
	Signal strength	N/A	N/A
	N/A	N/A	Select to toggle on/off repeat function. The icon is colored when the function is active.
	N/A	N/A	Select to toggle on/off shuffle mode. The icon is colored when the function is active.

Icon	Tuner	VHF	Playback
	Select to power on/off the active source. This button location is dependent on your unit's size. It is on the main Audio controller panel on larger units, and on the Audio controller's source panel on smaller units.		
	Select to display options for setting up zones and master control		
	Select to display the favorite stations for the tuner	Select to display the favorite channels for the VHF	Select to display the Device explorer. Use the explorer to access the source's native controller or file structure and to select tracks.
	Select to display optional settings for active source		

## Setting up the audio system



### Audio mixer

Use the Mixer to:

- Adjust the balance, volume, and volume limits individually for each zone.
- Adjust the bass and treble, and the balance between zones.
- Turn on or off individual speaker zones in the **Master control**.

The Mixer options vary depending on the activated audio device. The following is an example of the USB source mixer option for the **All Zones**:

- Bass
- Middle
- Treble

### The speakers

#### Speaker zones

The NSO evo3 can be set up to control different audio zones. The number of zones depends on the audio server connected to your system.

You can adjust balance, volume and volume limit settings individually for each zone. Adjustments to the bass and tremble settings will alter all zones.

#### Master volume control

By default the volume for all speaker zones are adjusted when you adjust the volume. You can define which zones will be altered when you increase/decrease the volume.

#### Selecting tuner region

Before playing FM or AM radio, and using a VHF radio, you must select the appropriate region for your location.

#### Favorite channels

When a tuner or VHF channel is tuned in, you can add the channel to your favorite list. The favorite channels can be viewed, selected and deleted from within the Favorite list.

You page through favorite channels by using the up/down Audio controller buttons.

## Pairing audio servers

Some NMEA 2000 compatible audio servers are Bluetooth enabled. You can use the Bluetooth devices icon in the Audio controller to pair the audio server with Bluetooth enabled audio devices such as a smart phone or tablet.

The following describes how to do this with a SonicHub 2 audio server.

To pair the SonicHub 2 to a Bluetooth enabled device select the Bluetooth devices icon in the Audio controller. Choose the Bluetooth device you want to pair to from the list of available devices and then select Pair.

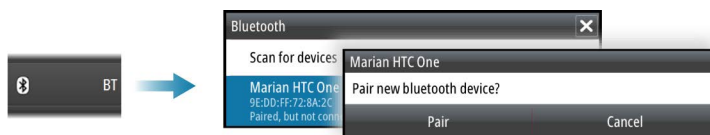

The SonicHub 2 connects to the paired device.

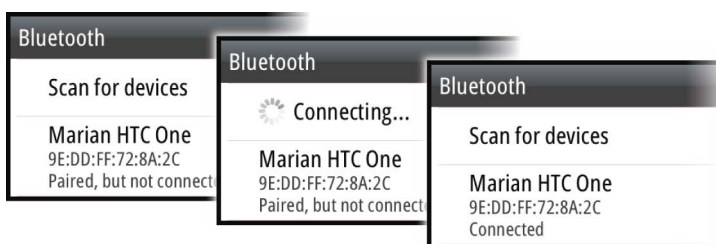

## Connecting and disconnecting paired devices

The SonicHub 2 automatically connects to a device when you pair them. You can pair it to several devices but only one device can be connected at a time.

You can manually disconnect and connect the SonicHub 2 to paired devices.

To disconnect a paired device, select the paired device in the device list and then select **Disconnect**.

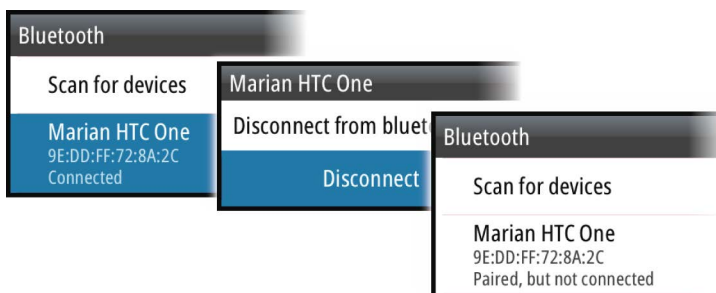

To connect to a paired device, select the paired device in the device list and then select **Connect**.

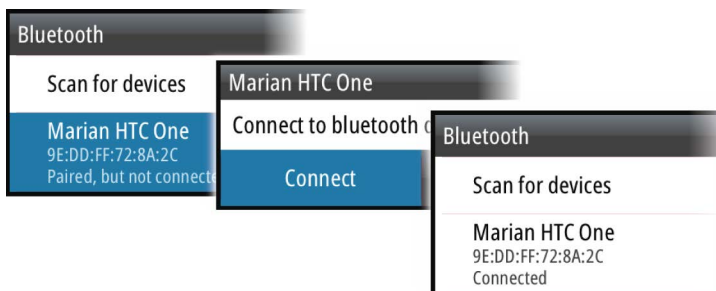

## Sirius radio (North America only)

When connected to a WM-3 Satellite module with an active subscription, you can include SiriusXM products on your system. You can also connect a SiriusXM radio to compatible audio servers. Sirius audio and weather service covers inland U.S. waters and coastal areas into the Atlantic and Pacific oceans, Gulf of Mexico, and the Caribbean Sea. The SiriusXM products received vary depending on your selected subscription package. For more information refer to [www.siriusXM.com](http://www.siriusXM.com) and the server documentation.

### Channels list

The channels list displays all available Sirius channels, whether or not you have a subscription for the channel.

### Favorites list

You can create a list of your favorite Sirius channels from within the channels list. You cannot add unsubscribed channels.

### Locking channels

You can lock selected Sirius channels from being broadcasted. A 4-digit-code must be entered to lock channels and the same code entered to unlock the channels.

### Auxiliary sources

AUX and AUX 2 (labeled AUX and SAT IN on the SonicHub) can be used for Sirius radio and external audio devices that support RCA connectivity. Sirius radio playback can be controlled when a Lowrance weather module is connected to SAT IN. Other auxiliary audio sources only have volume control.

#### Detaching Sirius from the AUX source

If a Sirius radio is connected to the FUSION radio/server, the AUX source is automatically attached to the Sirius feed. **Sirius** then appears in the source list when the FUSION server is active.

To use the AUX source for a different device, the Sirius must be detached from the AUX source.

→ **Note:** To use SiriusXM, an optional SiriusXM tuner must be connected to the FUSION server.

# 18

## Weather

The system includes weather functionality that allows the user to view forecast data overlaid on the chart. This helps gaining a clear understanding of the weather conditions that are likely to appear.





The system supports weather data in GRIB format, available for download from various weather service suppliers.

The system also supports weather data from SIRIUS Marine Weather Service. This service is available only in North America.

### Wind barbs

The rotation of the wind barbs indicate the relative wind direction, with the tail showing the direction the wind is coming from. In the graphics below, the wind comes from the northwest.

Wind speed is indicated by a combination of small and large barbs at the end of the wind tail.

	Zero knots / Indeterminate wind direction
	Small barb = 5 knots
	Large barb = 10 knots
	Arrow barb = 50 knots

If a combination of 5 and 10 knot barbs are shown on a tail, then add them together to give you the total wind speed. The example below shows 3 x large barb + 1 x small barb = 35 knots, and 60 knots indicated with 1 x arrow barb + 1 x large barb.

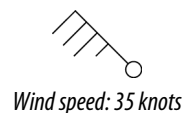

### Showing weather details

If pop-up is enabled, you can select a weather icon to display the identity of the observation. If you select the pop-up, detailed information about the observation is displayed. You can also display the detailed information from the menu when the weather icon is selected.

### GRIB weather

A GRIB file contains forecast information for a set number of days. It is possible to animate the weather data, which shows how weather systems are developing.

#### Importing GRIB data

GRIB data imported into memory can be displayed as chart overlay. Refer to "*Displaying GRIB weather as overlay*" on page 117. The file can be imported from any location that can be seen in the file manager.

→ **Note:** GRIB data that is imported overwrites the GRIB data in memory.

You can import the weather file using the File manager from the Tools panel or the Forecast menu option on the Chart panel:

- When you select a GRIB file with the File manager, the import option is available. Use it to import a GRIB file into memory.

Select the GRIB file to import the data.



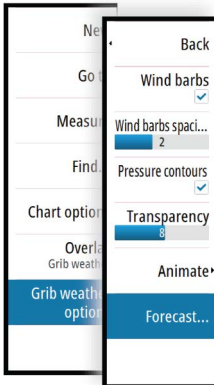
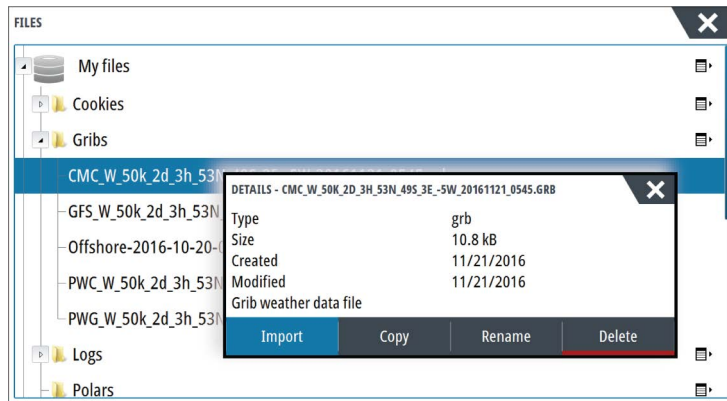

- Selecting the Forecast menu option on the Chart panel displays the GRIB weather dialog. Use the import file option in this dialog to open the File manager and import a GRIB file into memory. Using this dialog you can also select an available GRIB file. Selecting an available GRIB file is the same as importing the file into memory. Available GRIB files are files downloaded from a weather service supplier to the Gribs directory (in the Files manager).

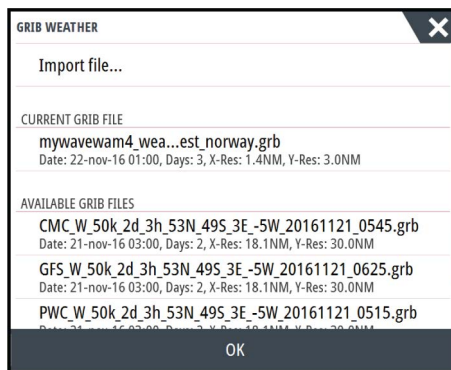

### Displaying GRIB weather as overlay

Imported GRIB weather data can be displayed as an overlay on your chart panel.

When the GRIB weather overlay is selected, the chart menu increases to show GRIB weather options. From this menu you can select which weather symbols you want to display, set the distance between the barbs, and adjust the opaqueness of the weather symbols.

From this menu you can also animate the weather forecast. Refer to "*Animating GRIB weather forecast*" on page 118.

The Forecast menu option displays the GRIB file currently in memory and overlaid on the chart. Select the Forecast menu option to import a new GRIB file into memory. Importing a new file overwrites the GRIB data in memory.

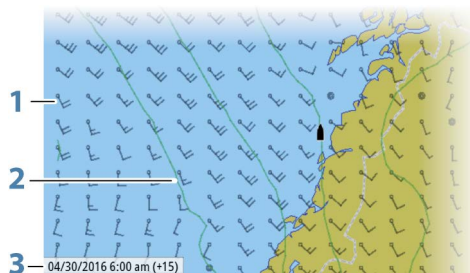
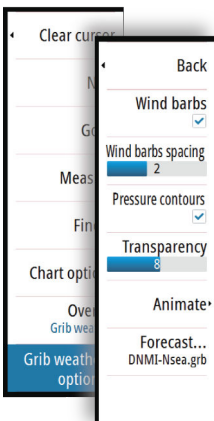

- 1 Wind barbs
- 2 Pressure contours
- 3 GRIB information window

## GRIB information window

The GRIB information window shows the date and time for the GRIB weather forecast, and the selected forecast time in brackets. A negative value in the brackets indicates historic weather data.

If you select a position on the chart, the information window expands to include weather details for the selected position.

## Animating GRIB weather forecast

The GRIB data contains forecast information for a set number of days. It is possible to animate the weather data and to show the predicted forecast for a specific time and date. The time scales vary depending on the file you are using.

The time shift is shown in brackets in the GRIB information window. The time is relative to the current time as provided by a GPS device connected to the system.

Select time and animation speed from the menu.

## SiriusXM weather

When connected to a Navico Weather module, you can subscribe and include Sirius audio and Sirius Marine Weather Service on your system (North America only).

Depending on your selected subscription package, Sirius audio and weather service covers a variety of North American inland waters and coastal areas. For more information refer to [www.siriusxm.com/sxmmarine](http://www.siriusxm.com/sxmmarine).

## Sirius status panel

When the weather module is connected to the system, you get access to the Sirius status panel.

The status panel shows signal strength is indicated as 1/3 (weak), 2/3 (good) or 3/3 (preferred). It also includes antenna status, service level, and the electronic serial number for the weather module.

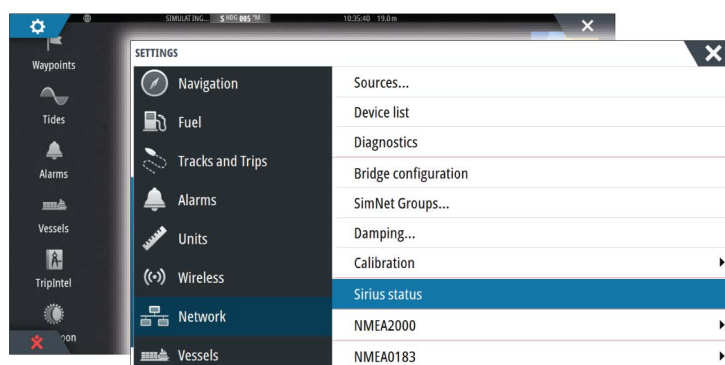

## Sirius weather display

Sirius weather can be displayed as an overlay on your chart panel.

When weather overlay is selected, the chart menu increases to show the available weather options.

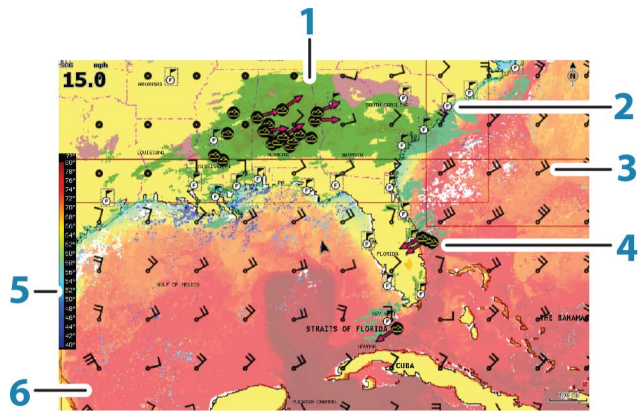

- 1 Precipitation color shading
- 2 City forecast icon
- 3 Wind barb
- 4 Storm icon
- 5 SST color bar
- 6 SST color shading

Use the Sirius weather option menu to select which weather symbology that should be displayed and how they should appear on the chart panel.

### Sirius view options

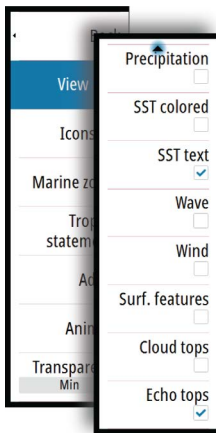

#### Precipitation

Shades of color are used to show precipitation type and intensity. The darkest color indicates the highest intensity.

Rain	From light green (light rain) - yellow - orange - to dark red (heavy rain)
Snow	Blue
Mixed	Pink

#### Sea Surface Temperature (SST)

You can show the sea surface temperature as color shading or as text.

When color coding is selected, the SST color bar is shown on the left side of the display.

You define how the color codes are used to identify sea surface temperature. See "*Adjusting color codes*" on page 121.

#### Wave indication

Colors are used to indicate forecasted wave height. The highest waves are dark red, while the lowest are blue.

You can define how the color codes are used to identify the wave height. Refer to "*Adjusting color codes*" on page 121.

#### Surface features

Turns surface features on/off. Surface features include fronts, isobars, and pressure points. Surface features cannot be shown at the same time as Wind.

#### Cloud tops

Turn Cloud tops on/off. Cloud tops indicate the height of the top of the clouds. The color palette used is grey with darker greys indicating lower clouds. Cloud tops cannot be shown at the same time as Precipitation or Echo Tops.

→ **Note:** This feature is only available for certain SiriusXM subscriptions.









### Echo tops

Turns Echo tops on/off. Echo tops indicate the tops of storms. The color palette used is the same as for Precipitation. Echo tops cannot be shown at the same time as Precipitation or Cloud Tops.

→ **Note:** This feature is only available for certain SiriusXM subscriptions.

### Weather icons

Several weather icons are available to show current or predicted weather conditions. You can select an icon to display detailed weather information.

	City forecast
	Surface observation
	Tropical storm tracking; past (grey) - present (red) - future (yellow)
	Hurricane (category 1-5) tracking; past (grey) - present (red) - future (yellow)
	Tropical disturbance/depression tracking; past (grey) - present (red) - future (yellow)
	Storm attributes
	Lightning
	Watch box location and warning
	Marine zone location

### Local weather

Select the Local weather menu option to display the Local weather dialog. This dialog shows weather forecast and alerts for the area.

Select a time-slot tab to see the forecast for it.

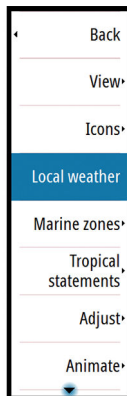

Local weather ✕

Now
3hrs
6hrs
Wed
Thur
Fri
Sat
Sun
Mon

N 25°51.499', W 80°13.134' Miami/Ft. Lauderdale (Hollywood/M... Florida

Precipitation: 0%

Air: Good

Cloud: Broken

UV: Low



**58°F**  
Partly Cloudy



5 mph

---

ALERTS

A Freeze Warning is in effect for Volusia and Lake Counties until Wed Jan 20 13:00:00 2016.  
 A freeze warning is issued for 2 or more hours of temperatures between 27 and 32 over a widespread area. Residents should cover or move indoors any cold sensitive plants, and bring pets indoors this evening.  
 /KMI R F7 W 0001V/

### Marine zones

Depending on your selected subscription, SiriusXM services includes access to weather reports for U.S. and Canadian Marine Zones, with the exception of the high seas zones.

You can select a marine zone on a chart and view its forecast. You can also select a marine zone as your current zone of interest and you will be notified of any weather warnings in that zone.

## Tropical statements

You can read tropical statements including information about tropical weather conditions. These statements are available for the entire Atlantic and the Eastern Pacific.

## Adjusting color codes

You can define the sea surface temperature range and wave height color coding.

The temperature above warm and below cool values is displayed as progressively darker red and darker blue.

Waves higher than the maximum value are indicated with progressively darker red. Waves lower than the minimum value are not color coded.

## Animating Sirius weather graphics

The NSO evo3 records the weather information you have turned on, and this information can be used to animate past or future weather conditions. The amount of information available in the system depends on the amount of weather activity; the more complex it is, the less time that is available for animation.

You can animate the past or the future, depending on which weather view you have turned on:

- With precipitation overlay, you can animate for the past and only assume weather conditions in the immediate future.
- With colored wave height overlay, you can animate the future (the predictions).

When activated, the time for the current graphic animation is displayed in the lower left corner of the chart panel.

## Weather alarms

You can setup lightning or storm alarms to occur when the conditions are within a certain range of your vessel.

You can also set up an alarm as a severe weather forecast alarm issued for your chosen marine zone.

A watchbox is defined by the National Weather Service. When the alarm for watchbox is turned on, an alarm occurs when your vessel is entering or inside a watchbox.

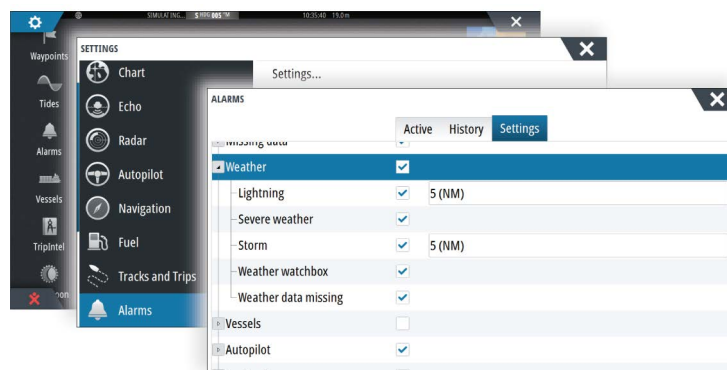
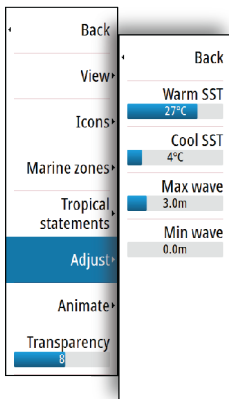

# 19

## Video

The video function allows you to view videos or camera sources on your system.

→ **Note:** The video images are not shared from the Ethernet network. You can only view the video on the unit connected to the video source.

If a compatible FLIR M-series camera is available on the Ethernet network, you can display the video and control the camera from the system.

For information about how to connect the camera, see the separate NSO evo3 Installation manual.

### The Video panel

A video panel can be set up as a single panel, or as one of the panels on a multiple panel page.

The video image is proportionally scaled to fit into the video panel. Areas not covered by the image are colored black.

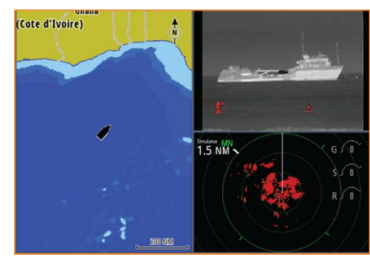

### Setting up the video panel

#### Video source

The unit supports two video input channels. You can select to view one channel only, or to cycle the image between available video cameras.

The unit also supports video input through the HDMI input connector.

The cycle period can be set from 5 to 120 seconds.

#### Video standard

NSO evo3 supports NTSC and PAL video. Check the local video standard or the standard of your cameras.

#### Adjusting the video image

You can optimize the video display by adjusting the video image settings. The settings are adjusted individually for each video source. Default for all settings: 50%.

### FLIR camera control

When the connection is established to a compatible FLIR camera, the menu changes to include access to FLIR camera controls.

→ **Note:** You can take over camera control from any NSO evo3 connected to the Ethernet network.

#### Establishing connection with the FLIR video camera

When a video panel is active, the unit automatically recognizes the compatible FLIR camera if it is available on the Ethernet network.

→ **Note:** When there is a DHCP server present on the Ethernet network, the FLIR camera needs to be configured and set to have a Static IP Address before the connection can be established. For instructions on how to configure your specific FLIR camera model, refer to FLIR documentation.

→ **Note:** Only one FLIR camera can be connected to the Ethernet network.

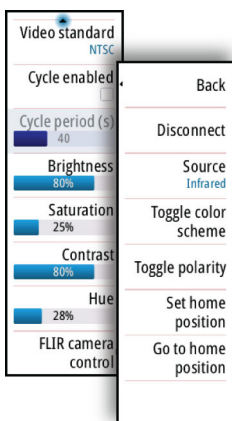

When you activate a video panel, the system starts searching the Ethernet network for a compatible FLIR camera.

Lost connections are indicated by a panel key. Select this key to reestablish the connection.

When the connection is established the menu changes to include access to FLIR camera control.

→ **Note:** You can take over camera control from any compatible unit connected to the Ethernet network.

### **Panning and tilting the FLIR camera**

When the connection to the FLIR camera is established, pan and tilt panel buttons appear on the video panel. The left and right arrow buttons control the camera's pan. The up and down arrow buttons tilt the camera.

Select one of the arrow buttons on the panel to control the camera. The camera continues to move for as long as you press the button.

### **Zooming the FLIR video image**

You zoom the video image by using the zoom panel buttons.

There are two zoom options available, depending upon your selected FLIR camera source option:

- **Digital zoom**  
Only available when the camera is in Infrared mode. In this mode, the zoom is represented in levels (0, 2 and 4 times zoom). Each press on a zoom button increments or decrements the zoom level.
- **Optical zoom**  
Available in daylight mode. In this mode, the camera continues to zoom for as long as you press a zoom panel button.

### **The FLIR camera source options**

The FLIR camera includes both daylight and infrared video sources.

When the infrared source is selected, the following options are available:

- **Toggle color scheme**  
Cycles through FLIR's video output color scheme. Each of these schemes maps a different color to a different temperature.
- **Toggle polarity**  
Inverts the color scheme. For example, instead of: White = Hot and Black = Cold, it becomes Black = Hot and White = Cold.

### **The FLIR camera's home position**

You can set the current pan and tilt position as the camera's home position.

You can later quickly return to this camera position.

# 20

## Time plots

The NSO evo3 can present data history in different plots. The plots can be displayed in full page, or combined with other panels.

### The Time plot panel

The Time plot panel consists of two predefined layouts. You switch between the layouts by selecting the left and right panel arrows. You can also select the layout from the menu.

You can select which data to present on a time plot panel, and you can define the time range for each plot.

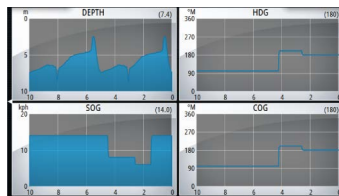

Layout 1

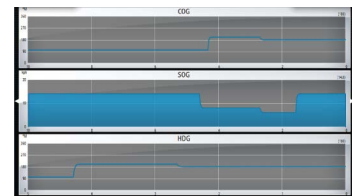

Layout 2

### Missing data

If the data is unavailable, the relevant plot turns into a dashed line and flattens out at the point the data was lost. When the data becomes available again, a dashed line joins up the two points showing an average trend line bridging the missing data.

### Selecting data

Each data field can be changed to show the preferred data type and the time range.

1. Select the edit option from the menu
2. Activate the field you want to edit
3. Change the information type and eventually the range
4. Save your changes

The data available for the Time plots are by default the sources used by the system. If more than one data source is available for a data type you can select to show alternative data source in the Time plot. You change the data type by using the data source option in the menu.



# 21

## Alarms

### Alarm system

The system continuously checks for dangerous situations and system faults while the system is running. When an alarm situation occurs, an alarm message pops up on the screen.

An alarm icon is displayed in the status bar, and the status bar pulses the color of the alarm.

If you have enabled the siren, the alarm message is followed by an audible alarm.

The alarm is recorded in the alarm listing so that you can see the details and take the appropriate corrective action.

### Type of messages

The messages are classified according to how the reported situation affects your vessel. The following color codes are used:

Color	Importance
Red	Critical
Orange	Important
Yellow	Standard
Blue	Warning
Green	Light warning

### Single alarms

A single alarm is displayed with the name of the alarm as the title, and with details for the alarm.



### Multiple alarms

If more than one alarm is activated simultaneously, then the alarm message displays a list of up to 3 alarms. The alarms are listed in the order they occur with the alarm activated first at the top. The remaining alarms are available in the Alarms dialog.

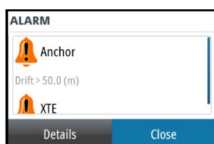

### Acknowledging a message

The following options are available in the alarm dialog for acknowledging a message:

- **Close**  
Sets the alarm state to acknowledged, meaning that you are aware of the alarm condition. The siren / buzzer stops and the alarm dialog is removed. However, the alarm remains active in the alarm listing until the reason for the alarm has been removed.
- **Disable**  
Disables the current alarm setting. The alarm does not show again unless you turn it back on in the Alarms dialog.

There is no time-out on the alarm message or siren. They remain until you acknowledge the alarm or until the reason for the alarm is removed.

### Alarms settings

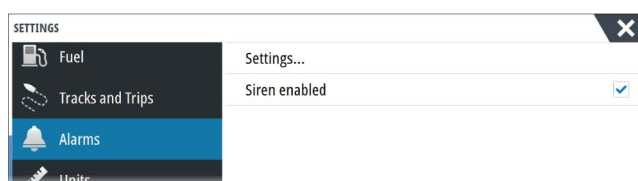

## Siren enable

The Siren enabled option must be set in order for the unit to activate the buzzer when an alarm condition arises.

Its setting also determines the operation of the external alarm output.

## Alarms dialog

All alarms are setup in the Alarms Settings dialog.

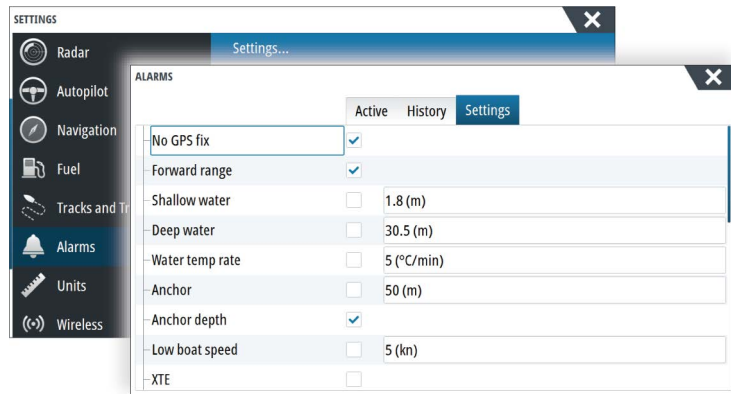

The alarm dialogs can also be activated from the Tools panel. The alarm dialogs include information about active alarms and alarm history.

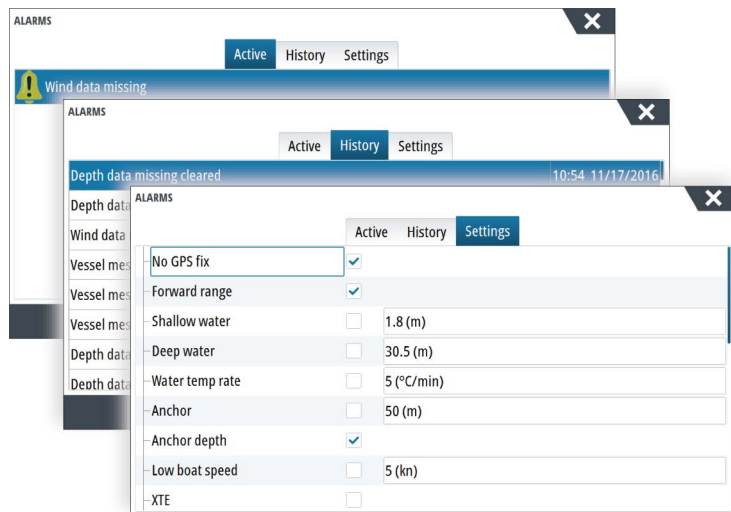
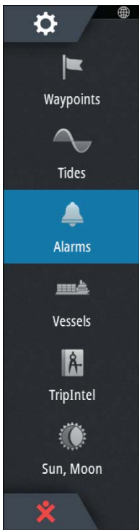

# 22

## Tools

By default, the Tools panel includes icons used for accessing options and tools that are not specific to any panel.

When external equipment is integrated to the unit, new icons might be added to the Tools panel. These icons are used for accessing the external equipment's features.



### Waypoints

List of waypoints, routes, and tracks with details.

Select the waypoint, route, or track you wish to edit or delete.

### Tides

Displays tide information for the tide station nearest to your vessel.

Select the arrow panel buttons to change the date, or select the date field to access the calendar function.

Available tide stations can be selected from the menu.

### Alarms

#### Active alarms

List of active alarms.

#### Alarm history

List of all alarms with time stamp.

#### Alarm settings

List of all available alarm options in the system, with current settings.

### Vessels

#### Status listing

List of all AIS, MARPA, and DSC vessels with available information.

#### Message listing

List of all messages received from other AIS vessels with time stamp.

### TripIntel

Provides trip management functionality and trip information. For more information, refer to "*TripIntel*" on page 51.

### Sun, Moon

Displays sunrise, sunset, moonrise and moonset for a position based on entered date and the position's latitude/longitude.

### Files

File management system, used to browse the contents of the unit's internal memory and storage devices connected to the unit.

#### Viewing files

Select a file in the Files panel and then the view file option in the **Details** dialog.

#### Copying files to a storage device

You can copy user data such as screen captures, logs, etc. to a storage device connected to the unit. You can also export user data such as System Settings, Waypoints, Routes, and Tracks to the storage device. Exporting files is covered in the section "*Maintenance*" on page 131.

## Find

Search function for chart items (waypoints, routes, tracks, etc.).

## GoFree Shop

→ **Note:** The built-in wireless functionality must be connected to an external wireless hotspot in order to access the GoFree Shop. Refer to "*Connect and disconnect from a wireless hotspot*" on page 102.

Opens the GoFree Shop web site. At the GoFree Shop you can browse, purchase, and download compatible charts for your system. You can also upload your Echosounder logs to be shared on Social Map charts.

# 23

## Simulator

The simulation feature lets you see how the unit works in a stationary position and without being connected to sensors or other devices.

The status bar indicates if the simulator is toggled on.

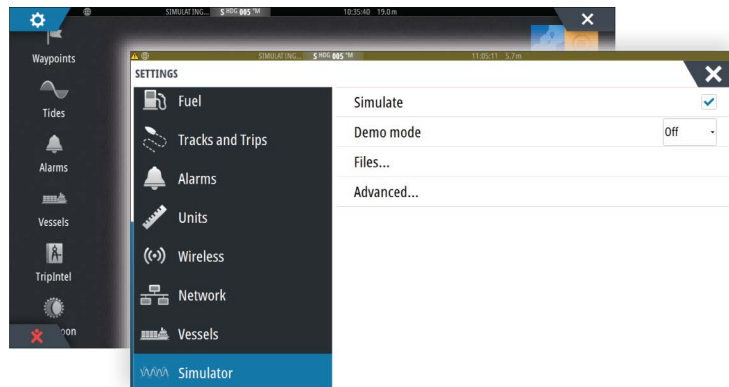

### Demo mode

In this mode the unit automatically runs through the main features of the product; it changes pages automatically, adjusts settings, opens menus, etc.

If you tap on a touchscreen or press a key when demo mode is running, the demonstration pauses. After a time-out period, demo mode resumes and any changed settings are restored to default.

→ **Note:** Demo mode is designed for retail/showroom demonstrations.

### Simulator source files

You can select which data file is used by the simulator. A set of source files is included in your system, and you can import files from a storage device connected to the unit. You can also use your own recorded log files in the simulator.

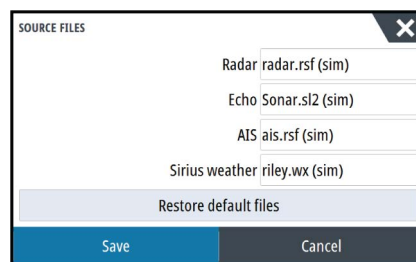

### Advanced simulator settings

The Advanced simulator settings allows for manually controlling the simulator.

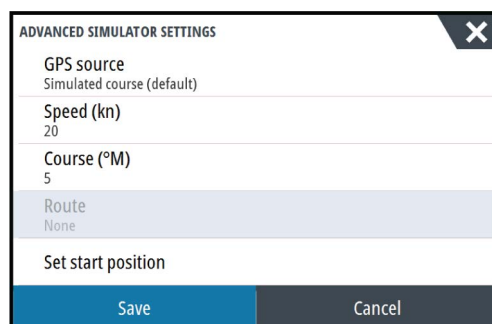

**GPS source**

Selects where the GPS data is generated from.

**Speed, Course and Route**

Used for manually entering values when GPS source is set to Simulated course or Simulated route. Otherwise, GPS data including speed and course come from the selected source file.

**Set start position**

Moves your vessel to the current cursor position.

→ **Note:** This option is only available when the GPS source is set to Simulated course.

# 24

## Maintenance

### Preventive maintenance

The unit does not contain any field serviceable components. Therefore, the operator is required to perform only a very limited amount of preventative maintenance.

If a sun cover is available, it is recommended that you always fit it when the unit is not in use.

### Cleaning the display unit

To clean the screen:

- A micro-fiber or a soft cotton cloth should be used to clean the screen. Use plenty of water to dissolve and take away salt remains. Crystallized salt, sand, dirt, etc. can scratch the protective coating if using a damp cloth. Use a light fresh water spray then wipe the unit dry with a micro-fiber or a soft cotton cloth. Do not apply pressure with the cloth.

To clean the housing:

- Use warm water with a dash of liquid dish soap or detergent.

Avoid using abrasive cleaning products or products containing solvents (acetone, mineral turpentine, etc.), acid, ammonia, or alcohol as they can damage the display and plastic housing.

Do not use a jet or high pressure wash. Do not run your unit through a car wash.

### Checking the connectors

The connectors should be checked by visual inspection only.

Push the connector plugs into the connector. If the connector plugs are equipped with a lock, ensure that it is in the correct position.

### NMEA Data logging

All serial output sentences sent over the NMEA TCP connection are logged to an internal file. You can export and review this file for service and fault finding purposes.

The maximum file size is predefined. If you have added several other files to the system (file recordings, music, pictures, PDF files), this may reduce the allowed file size for the log file.

The system logs as much data as possible within the file size limitation, and then it starts overwriting the oldest data.

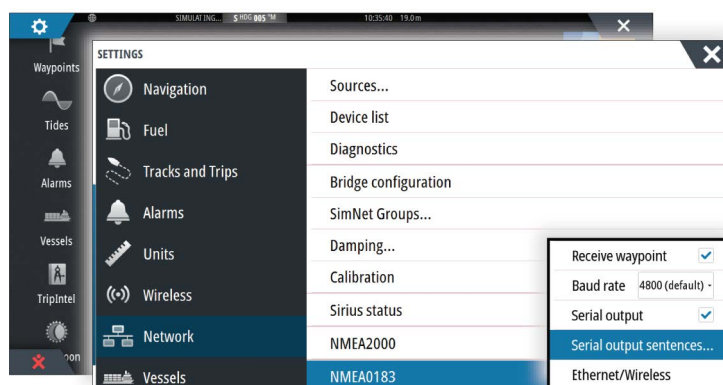

### Exporting the log file

The log file can be exported from the files dialog.

When you select the Log database you are prompted to select a destination folder and filename. Once accepted, the log file is written to the chosen location.

## RSD sentence output

The output of RSD NMEA 0183 message can be enabled (default off) to provide cursor position information to an external device. The cursor position information may be used by devices such as thermal cameras with pan-tilt ability, and external radar displays.

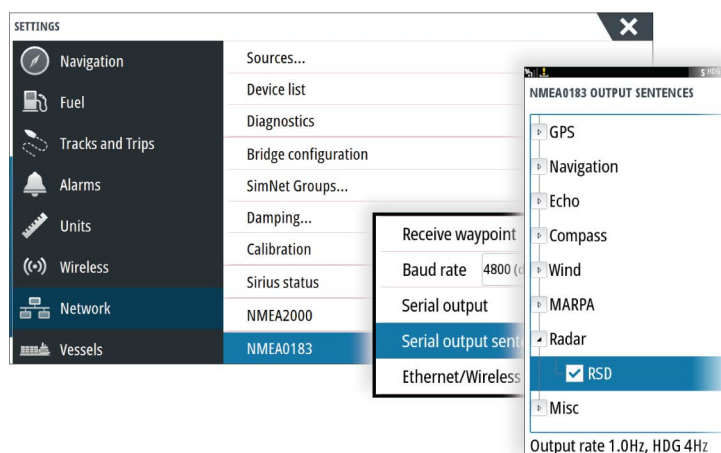

→ **Note:** The sentence format (dictated by NMEA 0183) was not written to take in to consideration dual radar systems, and therefore does not transmit identification information to distinguish between sources. When two radar PPIs are shown on the screen at the same time, only the first (left hand) radar provides RSD information. **RSD** is shown on the radar PPI to indicate this feature is enabled.

## Software upgrades

The latest software is available for download from our website, [www.simrad-yachting.com](http://www.simrad-yachting.com). Before initiating an update to the unit itself, be sure to back up any potentially valuable user data. Refer to "*Backing up your system data*" on page 133.

The system or the Network analyzer and service assistant can advise software updates are available.

### Network analyzer and service assistant

The system has a built-in service assistant that creates a report of the devices installed on the NMEA 2000 and Ethernet network such as the software versions, serial numbers, and information from the settings file to assist in technical support enquiries.

To use the analyzer, open the About page of the System settings dialog and select Support. Two options are displayed:

#### Create report

Analyzes your network and prompts you for information required for support and creates the report with information automatically gathered from the network. You can add screenshots and log files that will be attached to the report. There is a 20MB limit for the report attachments. You can save the report to a storage device and email it to support or upload it directly if you have an internet connection. If you call technical support first, you can enter an incident number to assist with tracking.

#### Check system for updates

Analyzes your network and checks if updates are available for compatible devices.

→ **Note:** Connect your unit to the internet to check for the latest available software versions. The software versions will be up to date as of the last time you updated your unit or connected to the internet.



## Update software

- **Note:** Remove any mapping cards from your unit and install a memory card with sufficient storage before downloading software updates or creating and saving reports to the memory card.
  - **Note:** Do not turn off the MFD or device until the update is completed or you are prompted to restart the unit or device being updated.
  - **Note:** Ensure there is enough space on the storage device or internal memory for the update file. To check how much free space is available, open the Files dialog from the tool panel. Select My files or the storage device in the Files dialog and then select the details option.
1. If your MFD is connected to the Internet, you can download the software update from the Updates Dialog onto a storage device or internal memory. You can also download the software update from [www.simrad-yachting.com](http://www.simrad-yachting.com) to a compatible storage device inserted in a smart device or PC connected to the internet.
  2. If the software update file is on a storage device, connect it to your unit. Otherwise skip this step.
  3. Select the item to be updated in the Updates Dialog and follow the prompts.

As you respond to the prompts the update occurs. Prompts may request that you restart the device to complete the update. You can restart devices to complete the update later at a more convenient time.

## Backing up your system data

Waypoints, Routes, and Tracks that you create are filed in your system. It is recommended to regularly copy these files and your system settings files as part of your back-up routine.

The files can be copied to a storage device connected to the unit.

There are no export file format options for the system settings file. The following output formats are available for exporting Waypoints, Routes, and Tracks files:

- **User Data File version 6**  
This is used to import and export waypoints, routes and colored Tracks.
- **User Data File version 5**  
This is used to import and export waypoints and routes with a standardized universally unique identifier (UUID), which is very reliable and easy to use. The data includes such information as the time and date when a route was created.
- **User Data File version 4**  
This is best used when transferring data from one system to another, since it contains all the extra bits of information these systems store about items.
- **User Data file version 3 (w/depth)**  
Should be used when transferring user data from one system to a legacy product (Lowrance LMS, LCX)
- **User data file version 2 (no depth)**  
Can be used when transferring user data from one system to a legacy product (Lowrance LMS, LCX)
- **GPX (GPS Exchange, no depth)**  
This is the format most used on the web that shares among most GPS systems in the world. Use this format if you are taking data to a competitor's unit.
- **Northstar.dat (no Tracks)**  
Used to transfer data to a legacy Northstar device.

## Export all Waypoints, Routes and Tracks

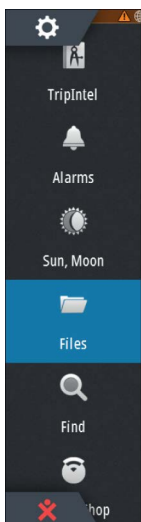

Use the export option if you want to backup all Waypoints, Routes, Tracks and Trips on your system.

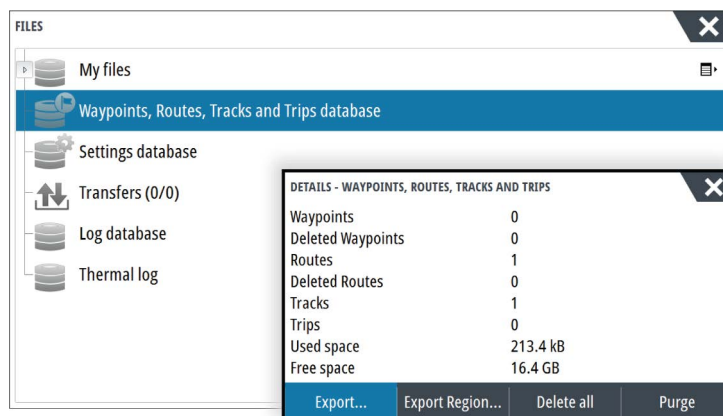

### Export region

The export region option allows you to select the area from where you want to export data.

1. Select Export region
2. Drag the boundary box to define the desired region



3. Select the export option from the menu
4. Select the appropriate file format
5. Select the serial port field to start the export

### Purging Waypoints, Routes and Tracks

Deleted Waypoints, Routes and Tracks are stored in the display unit's memory until the data is purged. This is necessary to allow user data to be synchronized across multiple units on an Ethernet network. If you have numerous deleted, unpurged Waypoints, purging may improve the performance of your system.

→ **Note:** When user data is purged from the memory, it cannot be recovered.

### Importing a database

Later, if the unit has been restored to factory defaults or user data is accidentally deleted, return to the files page, select the backed up file, and then **Import**. View file details for creation date.







# 25

## Appendix

### Touchscreen operation

Basic touchscreen operation on the different panels is shown in the table below.

The panel sections in this manual have more information about panel specific touchscreen operation.

Icon	Description
	Tap to: <ul style="list-style-type: none"><li>• Activate a panel on a multi-panel page</li><li>• Position the cursor on a panel</li><li>• Select a menu and a dialog item</li><li>• Toggle a checkbox option on or off</li><li>• Show basic information for a selected item</li></ul>
	Press and hold: <ul style="list-style-type: none"><li>• On any panel with a cursor to either activate the cursor assist feature or open the menu. Refer to "<i>Customizing the long press feature</i>" on page 20</li><li>• On the Instrument panel to open the Choose data dialog</li><li>• On a panel button to see available split screen options</li><li>• On a favorite button to enter edit mode</li></ul>
	Scroll through a list of available options without activating any option.
	Flick to quickly scroll through e.g. the waypoint list. Tap the screen to stop the scrolling.
	Pan to position a chart or Echosounder image on the panel.
	Pinch to zoom out on the chart or on an image.
	Spread to zoom in on the chart or on an image.

### Key operation overview

All keys on the keyboard work as usual when entering keys in a text field.

Keyboard operation and shortcuts are shown in the table below. Unless noted all references are single short presses on the key.

→ **Note:** The shortcuts refer to US keyboard layout. Some shortcuts may not work on different national keyboards.

Keyboard keys	Function
Menu	Opens the menu
Ctrl + M	
F1	Opens the Home page
Ctrl + P	
F2	Opens the Chart page
Ctrl + H	
F3	Opens the Radar page
Ctrl + R	
F4	Opens the Echo page
Ctrl + E	
F5	Opens the Nav page
Ctrl + N	
F6	Opens the Instrument page
Ctrl + I	
F12 (press and hold)	Positions a MOB mark at vessel position
Ctrl (double click)	Switches control to next monitor connected to the unit (USB port must be set to switchable)
Ctrl + B	Centers the chart on vessel position
Ctrl + D	Switches between panels on a multi-panel page
Ctrl + G	Opens the Goto menu
Ctrl + K	Places a waypoint at vessel/cursor position
Ctrl + L	Acts as the Wheel key, which can be configured.
Ctrl + O	Opens the New Waypoint dialog
Ctrl + Q	Opens the System Controls dialog
Ctrl + S	Switches the autopilot system to STANDBY mode
Ctrl + U	Switches the autopilot system to Heading hold mode
Ctrl + ;	Displays the Favorite panel as pop-up on active page
Ctrl + \	Take screenshot
PrintScn	
Esc	<ul style="list-style-type: none"> <li> Cancels changes and returns to previous menu level</li> <li> Closes an open menu</li> </ul>
Enter	Activates/confirms current selection
Arrow keys	Move the cursor on the panel, and maneuvers in the menus/dialogs
- and +	Zoom

## Using the mouse to control the system









The mouse pointer becomes visible when you move the mouse, and it will auto-hide after a few seconds of inactivity.











- Press the left button to position the cursor on a panel or to select an option. You can select text in an input field by keeping the left button pressed while moving the mouse
- Use the scroll wheel to zoom a zoomable panel or image, or to scroll through menu and dialog options

- The use of the right button depends on if the cursor is active or not.
  - With active cursor: press the button to display information about the item at cursor position
  - Without active cursor: press the key to toggle the panel menu on/off

## Status bar icon definitions

Depending on your system and set up, the following icons can appear on the status bar:

Icon	Definition
	Alarm - a standard (yellow), important (orange) or critical (red) alarm is sent. To remove the icon in the status bar, acknowledge the alarm in the Alarms dialog. If needed, change the alarm setting or remedy the situation so the same alarm is not resent immediately by the system.
	Autopilot modes: Auto-Heading hold, Follow up, Navigation, No drift, Standby. Use the autopilot controller to select an autopilot mode.
	Autopilot turns - autopilot is turning the vessel in a turn mode: C turn, Depth turn, S turns, Spiral turn, Square turn, ZigZag turns. In most cases, when the turn is completed the turn icon is replaced with an autopilot mode icon. Use the autopilot controller to select an autopilot turn or cancel the turn.
	Downloading files, e.g.: software update file, logs from C-MAP Genesis, GRIB weather files, PredictWind routes, etc.
	The unit is connected to the Internet. The unit can be used to download or upload files to the internet.
	No GPS signal. Clear view between the antenna and satellites with no obstructions is best. The placement of the GPS and obstructions between it and satellites can affect the signal strength (e.g. placing the GPS antenna in a room with metal walls and/or ceiling). Weather conditions can also affect the signal. Check cables and connectors if your system has an external GPS antenna. To see status of satellite signal fixes, open the system settings dialog and select the Satellites option.
	GPS signal strength: strong, medium, and weak. The placement of the GPS and obstructions between it and satellites can affect the signal strength. In some cases, a well-placed external GPS antenna might be needed.
	GPS signal strength with the Wide Area Augmentation System (WAAS) is strong, medium, and weak.
	An external keyboard is connected to the unit.
	An external mouse is connected to the unit.

Icon	Definition
	The system is simulating. Turn ON/OFF the simulator from the simulator settings dialog.
	Radar is paused. If you want the radar to transmit, select the transmit option in the Radar page menu.
	Radar is transmitting. If you want to pause the radar, select the pause option in the Radar page menu.
	An OP40 remote controller is connected to the unit
	An ZC1 remote controller is connected to the unit
	An OP50 or ZC2 remote controller is connected to the unit
	The system is synchronizing data during startup.
	File transfer problem, caused by an interruption in the internet communication.
	Trip recording. For more information, open the TripIntel tool option.
	Uploading files, e.g.: service report, C-MAP genesis, route files to PredictWind, etc.

# Index

---

## A

Adjusting panel size 20  
AIS 105  
  Calling a vessel 106  
  DSC 106  
  Icon filters 108  
  Icon orientation 109  
  Information on radar panels 106  
  Searching for AIS items 105  
  Target symbols 105  
  Viewing information about targets 105, 106  
AIS SART 106  
  Alarm message 107  
Alarm system 125  
Alarm  
  Critical Zone 99  
Alarms  
  Acknowledging 125  
  Alarm settings dialog 126  
  Multiple alarms 125  
  Single alarm 125  
  Type of messages 125  
App  
  GoFree Link 102  
Application pages 12  
Arrival alarm 50  
Arrival radius 49  
Audio 111  
  Controller 111  
  Auxiliary 115  
  Control buttons 112  
  Detaching Sirius 115  
  Enable 111  
  Favorite channels 113  
  Master volume control 113  
  Mixer 113  
  Operating 111  
  Selecting tuner region 113  
  Server selection 111  
  Setting up the system 113  
  Sirius radio 115  
  Speaker zones 113  
  Speakers 113  
Audio tools 112  
AUTO mode, see Heading hold mode 57  
Autopilot 55  
  Activating 55  
  Autopilot controller 56  
  Autopilot panel 56  
  Chart compass 66  
  Depth contour tracking 61  
  Dodging 58  
  EVC system 62  
  Follow-up steering 57  
  Gybing 60  
  Heading hold mode 57  
  Indication in Status bar 56

  Indication on pages 55  
  Modes 57  
  Non-Follow up mode 57  
  Standby (STBY) mode 57  
  Switching to manual steering 55  
  Tacking in Heading hold mode 58  
  Tacking in WIND mode 60  
  Turn pattern steering 60  
  Waypoint arrival circle 59  
Autopilot :WIND mode 59  
Autorouting, see Dock-to-dock  
Autorouting 42  
  Dock-to-dock 42  
Auxiliary, audio sources 115

## B

Backing up your system data 133  
Bottom lock 87  
Bridge Control 23  
  Adding displays 23  
  Bridge presets 24  
  Configuring the preset pages 24  
  Page configurations 23

## C

C-MAP chart options 33  
Card  
  Copying files to 127  
Charts 26  
  3D charts 31  
  C-MAP chart options 32  
  Chart compass 66  
  Chart data 26  
  Chart panel 26  
  Chart scale 27  
  Course up 27  
  Creating routes 29  
  Dual charts 26  
  Find chart objects 29  
  Heading up 27  
  Insight chart options 32  
  Look ahead 28  
  Measuring distance 29  
  Navionics chart options 36  
  North up 27  
  Overlay 31  
  Panning 27  
  Positioning the vessel on the chart panel 27  
  Preloaded cartography 26  
  Radar overlay source 70  
  Selecting chart type 27  
  Settings 39  
  Using the cursor 28  
  Vessel symbol 27  
  Zooming 27  
Color tracks

- Based on data 45
- Connect
  - Smartphone and tablet 102
  - Wireless hotspot 102
- Controller and viewer app
  - GoFree Link 102
- Converting tracks to routes 44
- Coordinate system 50
- Copying files to a storage device 127
- Critical Depth 99
- Critical Forward Range 99
- Critical Zone alarm 99
- Cursor assist 28, 71, 83, 91
  - Customize the long press feature 20
- Customizing your system 20
- CZone 14

## D

- Dangerous vessels 109
- Dashboards 110
- Database
  - Import 134
- Datum 50
- DCT 61
- Demo mode 129
- Depth line 88
- Disconnect
  - Wireless hotspot 102
- Dock-to-dock Autorouting
  - Entire route 43
  - Example 43
  - Selection 43
- Doppler coloring 75
- Dual Radar 69
- Dual range, Radar 70

## E

- Easy Routing 42
  - Example 43
- EBL/VRM markers 78
- Echosounder 82
  - A-Scope 88
  - Fish ID 88
  - Image 82
  - Pausing 85
  - Ping speed 86
  - Scroll speed 85
  - Split screen 87
  - Start recording echosounder data 86
  - Stop recording log data 87
  - Structure options 85
  - Using the cursor 83
  - View history 84
  - View options 87
  - View recorded data 87
  - Zoom bar 83
  - Zoom bars 88
  - Zooming 83
- Echosounder

- Split Zoom 87
- Export region 134
- Extension lines 109

## F

- Favorite pages 13
  - Adding new 21
  - Edit 22
- Feature unlock 15
- Files to a storage device, copying 127
- Files, management 127
- Files
  - Viewing 127
- Find items tool 128
- FLIR camera
  - Controlling 122
  - Digital zoom 123
  - Establishing connection 122
  - Home position 123
  - Integration 14
  - Optical zoom 123
  - Panning and tilting 123
  - Source options 123
  - Zooming 123
- ForwardScan 97
  - Critical Depth 99
  - Critical Forward Range 99
  - Critical Zone alarm 99
  - Heading extension 98
  - Image 97
  - Setup 99
  - Transducer angle 100
- Frequency 84
- Fuel economy gauge 23
- FUSION-Link 14

## G

- Go to cursor 28, 71, 83, 91
- GoFree
  - Shop 102
  - Wireless connection 102
- GoFree
  - Link 102
  - Smartphone connection 103
  - Tablet connection 102
- Great circle 49
- GRIB weather 116
  - Animated weather forecast 118
  - Importing data 116
  - Information window 118
  - Overlay on chart panel 117

## H

- Heat map
  - Overlay 32
- Home page background 20



## I

- Import
  - Database 134
- Improving system performance 134
- Insight chart options 33
- Instrument bar 22
  - Activity bar 22
  - Appearance 22
  - Edit the content 22
  - Fuel economy gauge 23
  - Turning on/off 22
- Instrument panels 110
- Integration of 3rd party devices 13

## K

- Keyboard 135

## L

- Long press feature
  - Customize 20

## M

- Magnetic variation 50
- Manuals, viewing 5
- Manual
  - Version 5
- Marine Search and Rescue 30
- Measuring distance 29, 83, 91
- MMSI number 108

## N

- Navigate 47
  - Arrival alarm 50
  - Arrival radius 49
  - Cancel navigating a route 49
  - Datum 50
  - Methods 49
    - Great circle 49
    - Rhumb lines 49
  - Nav panel 48
  - Panels 47
  - Position panel 48
  - Routes 48
    - To cursor position 48
    - With autopilot 49
- Navigation settings 49
- Navionics chart options 36
- NMEA Data logging 131
- NMEA
  - Exporting log file 131
- Noise rejection 85

## O

- Operation 135
  - Mouse 136
  - Touch 135
- Overlay

- Heat map 32

## P

- Palettes 88, 92
- Panels
  - Adjusting panel size 20
- Password protection 21
- PDF, viewing files 5
- Phantom Loran 50
  - Settings 50
- Pin code
  - Password protection 21
- Ping speed 86
- Preventive maintenance 131
- Purging 134

## R

- Radar 69
  - Alarm settings 79, 80
  - Course up 76
  - Dual 69
  - Dual range 70
  - EBL/VRM markers 78
  - EBL/VRM
    - Placing 78
  - EBL/VRM
    - Offset 78
  - Fast scan 74
  - Gain 73
  - Guard zone 79
  - Head-up 76
  - Interference 74
  - MARPA
    - Target symbols 79
    - Targets 79
    - Tracking targets 80
    - View target info 80
  - Motion mode 77
  - North up 76
  - Operational modes 70
  - Orientation 76
  - Overlay 70
  - Palette 76
  - Radar overlay source 70
  - Radar panel 69
  - Rain clutter 74
  - Range 70
  - Recording data 80
  - Sea clutter 73
  - Sea State 75
  - Sensitivity 79
  - Settings 81
  - Source 70
  - Target boost 75
  - Target expansion 74
  - Target trails 76
  - Threshold 74
- Range 84
- Record echosounder data 93

- Recording
  - Start recording echosounder data 86
  - Start recording log data 86
- Rhumb lines 49
- Routes 42
  - Converting tracks to routes 44
  - Creating a new route on the chart panel 42
  - Creating a route from existing waypoints 43
  - Delete 42
  - Dialog 46
  - Dock-to-dock Autorouting 42
  - Easy Routing 42
  - Edit in chart panel 42
  - Edit Route dialog 44
  - Navigate 48
- S**
- SAR 30
- Saving waypoints 29, 41, 71
- Scroll speed 85
- Sea State 75
- Search and Rescue 30
- Simulator 129
  - Demo mode 129
  - Source files 129
- Sirius radio 115
  - Channels list 115
  - Favorite list 115
  - Locking channels 115
- Sirius weather
  - Animated weather graphics 121
  - Color codes 121
  - Marine zones 120
  - Overlay on chart panel 118
  - Precipitation 119
  - Sea Surface Temperature (SST) 119
  - Status panel 118
  - Tropical statements 121
  - Wave indication 119
  - Weather icons 120
- SiriusXM weather 118
- SL2 format 86
- SL3 format 86
- SLG format 86
- SmartCraft VesselView 13
- Smartphone connection 103
- Software upgrade 132
- Software version 5
- Software
  - How to update 133
- Speaker zones 113
- Speakers 113
- Speed and course indication 109
- Split pages
  - Pre-configured 13
- Split screen
  - Echosounder 87
- Split zoom
  - Echosounder 87
- Storage device
  - Copying files 127
- StructureMap 86, 94
  - Activate 94
  - Image 94
  - Live source 94
  - Mapping cards 95
  - Options 95
  - Saved files 95
  - Sources 94
  - Tips 95
- StructureScan 90
  - Advanced settings 92
  - Auto range 92
  - Contrast 92
  - Convert data to StructureMap format 95
  - Custom range 92
  - Flipping the image 93
  - Frequencies 92
  - Image 90
  - Noise rejection 96
  - Pausing the image 92
  - Preset range levels 92
  - Range 92
  - Range lines 93
  - Recording data 95
  - Using the cursor 91
  - View down or side scan 92
  - View history 91
  - View options 90
  - Zooming 90
- System Settings
  - Coordinate system 50
  - Datum 50
  - Magnetic variation 50
- T**
- Tablet connection
  - GoFree, wireless 102
- Temperature graph 88
- Time plot panel 124
  - Missing data 124
- Time plots 124
  - Selecting data 124
- Tools 127
- Tools
  - Find items 128
- Touch
  - Operation 135
- Tracks
  - Dialog 46
- Tracks
  - Coloring 45
  - Creating new 44
  - Settings 44
- Transducer angle, ForwardScan 100
- Trip management 51
- TriplIntel 51

- Turn pattern steering
  - Autopilot 60
- TVG 85, 92

## U

- Unit
  - Checking the connectors 131
- Update software 133

## V

- VelocityTrack 75
- Vessel alarms 107
- Vessel settings 108
- Video 122
  - Adjusting the image 122
  - Setting up the panel 122
  - Source 122
  - Standard 122
- Video
  - Video panel 122
- View Echosounder log 89
- Viewing files 127

## W

- Wallpaper, customizing 20
- Waypoints, routes and tracks
  - Purging 134
- Waypoints, routes, trails and trips
  - Export 134
- Waypoints 41
  - Alarm settings 41
  - Delete 41
  - Dialog 46
  - Edit 41
  - Moving 41
  - Saving 29, 41, 71
- Weather 116
  - Alarms 121
  - Showing weather details 116
- Wind barbs 116
- Wireless hotspot
  - Connect and disconnect 102
- Wireless
  - Devices details 104
  - Enable or disable the internal wireless 104
  - Smartphone connection 103
  - Tablet connection 102

## X

- XTE limit 50
- xtf format 86

## Y

- Yamaha engine integration 14



**SIMRAD**