

How To: Marine Electrical Design

Seattle Boat Show 2021

Presented by
Jeff Cote

Pacific  Yacht Systems
marine electronics & electrical
design • installation • service • support

Passion for Boating



- Systems Design Engineer
- Owner/operator of Pacific Yacht Systems
- NMEA & ABYC certifications
- Published monthly columns
 - Pacific Yachting Magazine: Tech Talk
 - Northwest Yachting Magazine: Hot Wire
- Proud boat owner: 36' Sailboat
- Favorite British Columbia cruising grounds
 - Barkley Sound and Broughton Archipelago

About Pacific Yacht Systems Inc.



- Specialize in marine electrical and electronics
- Servicing British Columbia and Western Canada
- Worldwide electrical consultation & design
- 2020 Recap:
 - Completed over 1000 boat projects
 - Consulted & design on over 400 electrical projects
- Over 250 “How To” PYS Videos on YouTube
- www.pysystems.ca for schematics, design info, published articles, etc...

Notes



- About questions
- Presentation slides available online
 - pysystems.ca/media
- Emphasis on conceptual diagrams
- DIY boaters
 - PYS provides consultation & design services

Conceptual Diagram – DC Overview

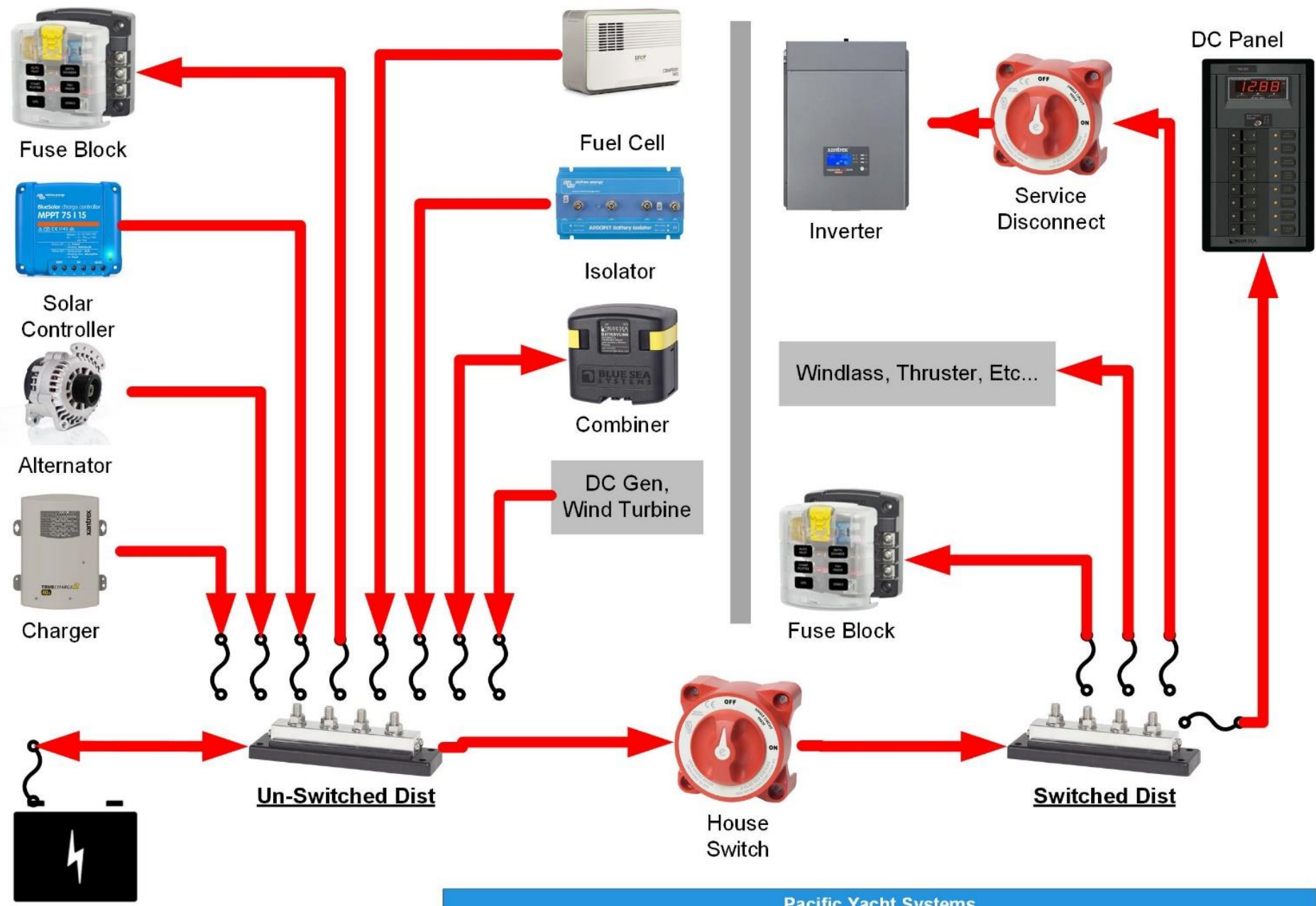

House Battery

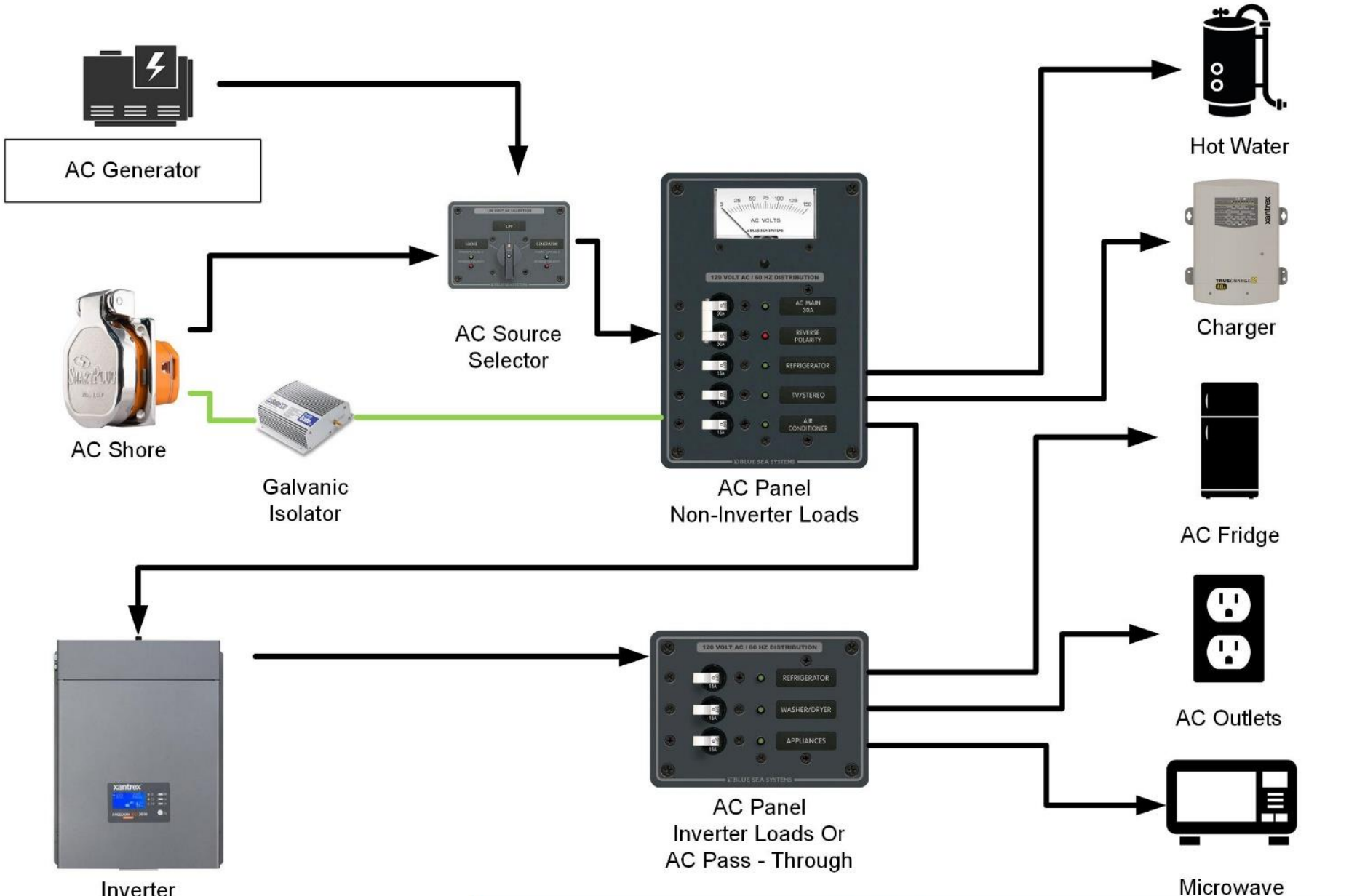

Starting Point



- List of all AC and DC loads onboard
 - Average running AC and DC loads
- Battery energy consumed between charges
 - Daily amp-hour consumption
- Frequency of charging
 - Battery charger, alternator, solar panel, fuel cell, wind
- Number of battery banks
- 12 vs 24 VDC
- 120 vs 220 VAC



Energy Storage

Batteries

Marine Batteries



Battery Chemistry: Three Main Choices



- Flooded Lead Acid
 - Starter
 - Deep-Cycle
 - Dual
- Sealed Valve Regulated Lead Acid
 - Gel
 - AGM (Absorbed Glass Mat)
 - Carbon Foam AGM (i.e. Firefly)
- Lithium Phosphate (LiFePO_4)

AGM vs Firefly vs Flooded Summary



	AGM	Firefly AGM	Flooded
Initial Cost	\$\$	\$\$\$	\$
Battery Life	1X	4X	1X
Useable capacity	55%	65%	35%
Maintenance	None	None	Regular top-off
Self-discharge	2% per month	2% per month	15% per month
Purpose	Dual	Dual	Single
Sulfation	Yes	No	Yes

Battery Install: Firefly Examples

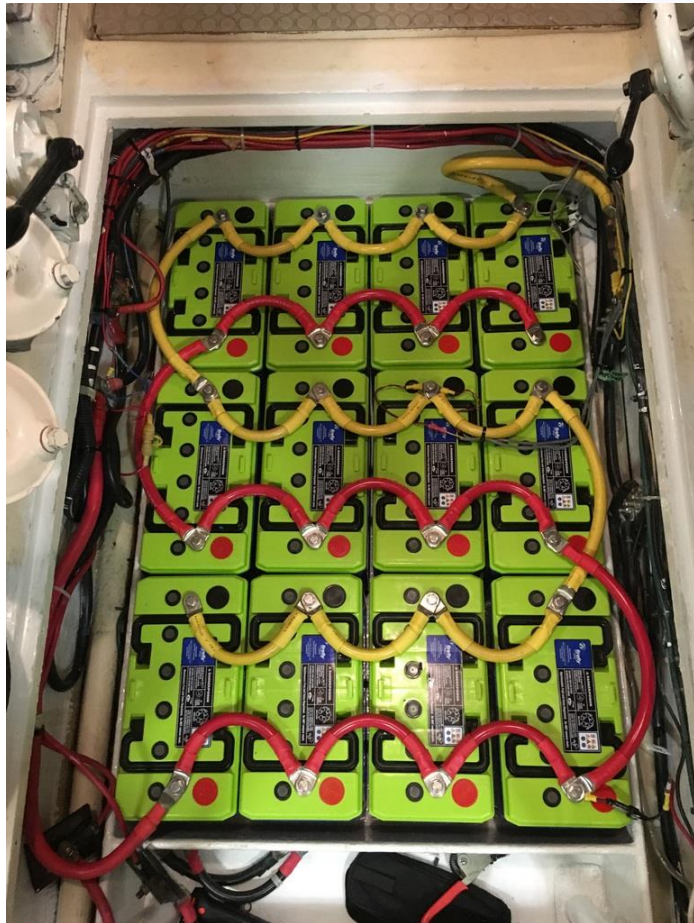

Battery Bank: Design Tips



- Wire battery positive and negative at opposite ends
- Battery bank in one location
- Flooded lead acid batteries installed in leak proof container
- Keep battery load connections to a minimum
 - Modular and distribution
- Fuse all leads to battery (except starter)
- Install battery bank disconnect switch



Power Generation

Charger

Inverter/Charger

Alternator

Solar

Fuel cell

Conceptual Diagram – DC Overview

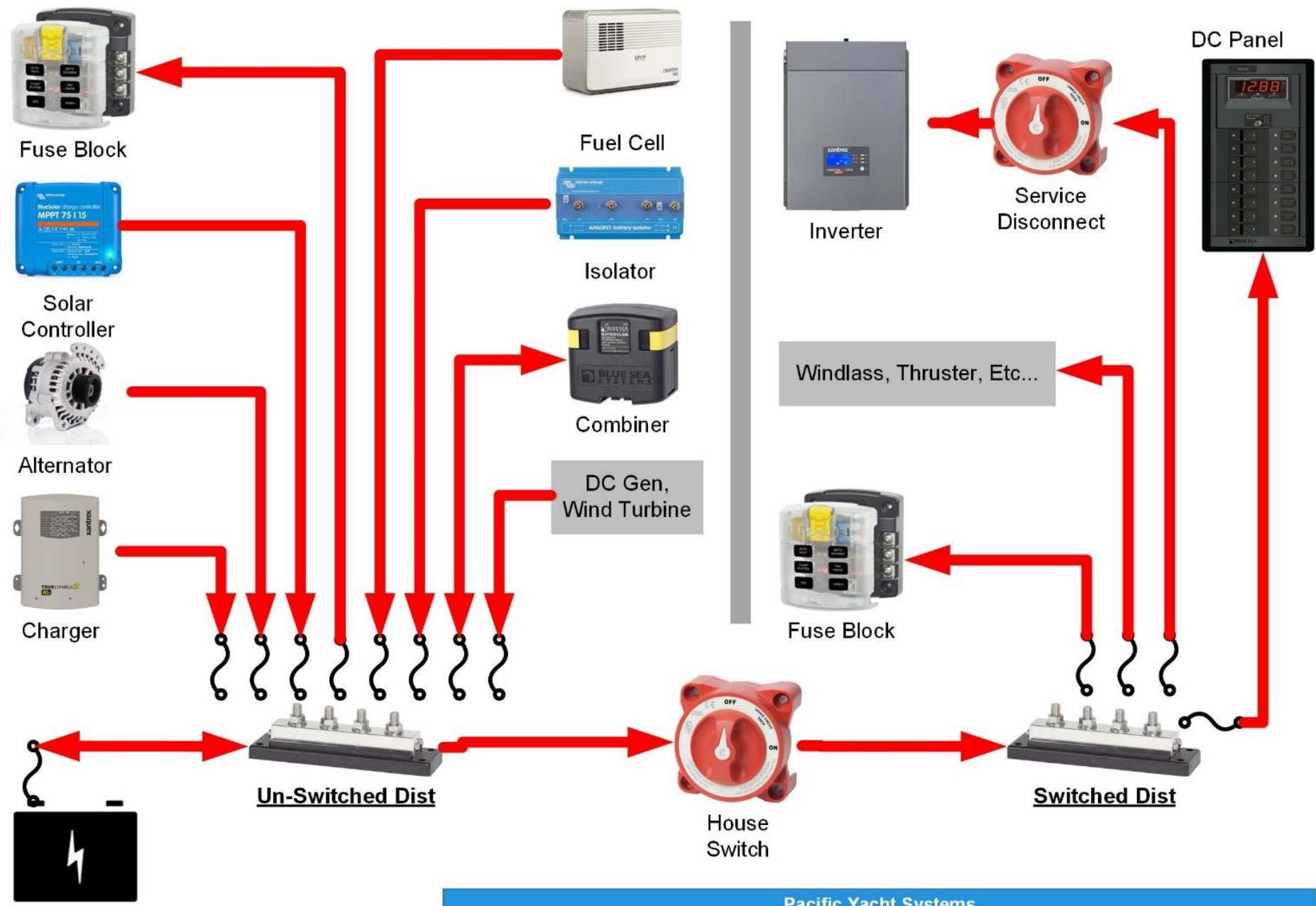

House Battery

Charge Rate for Batteries



- Importance of sizing **minimum** charge rate to battery size
 - **Minimum: ~ 10% of capacity**
- Reduce your charging time by increasing your charge rate
 - **Maximum: ~ 25% of capacity (AGM/Gel: ~ 40%)**
 - How often to you want to run genset/engine per day?

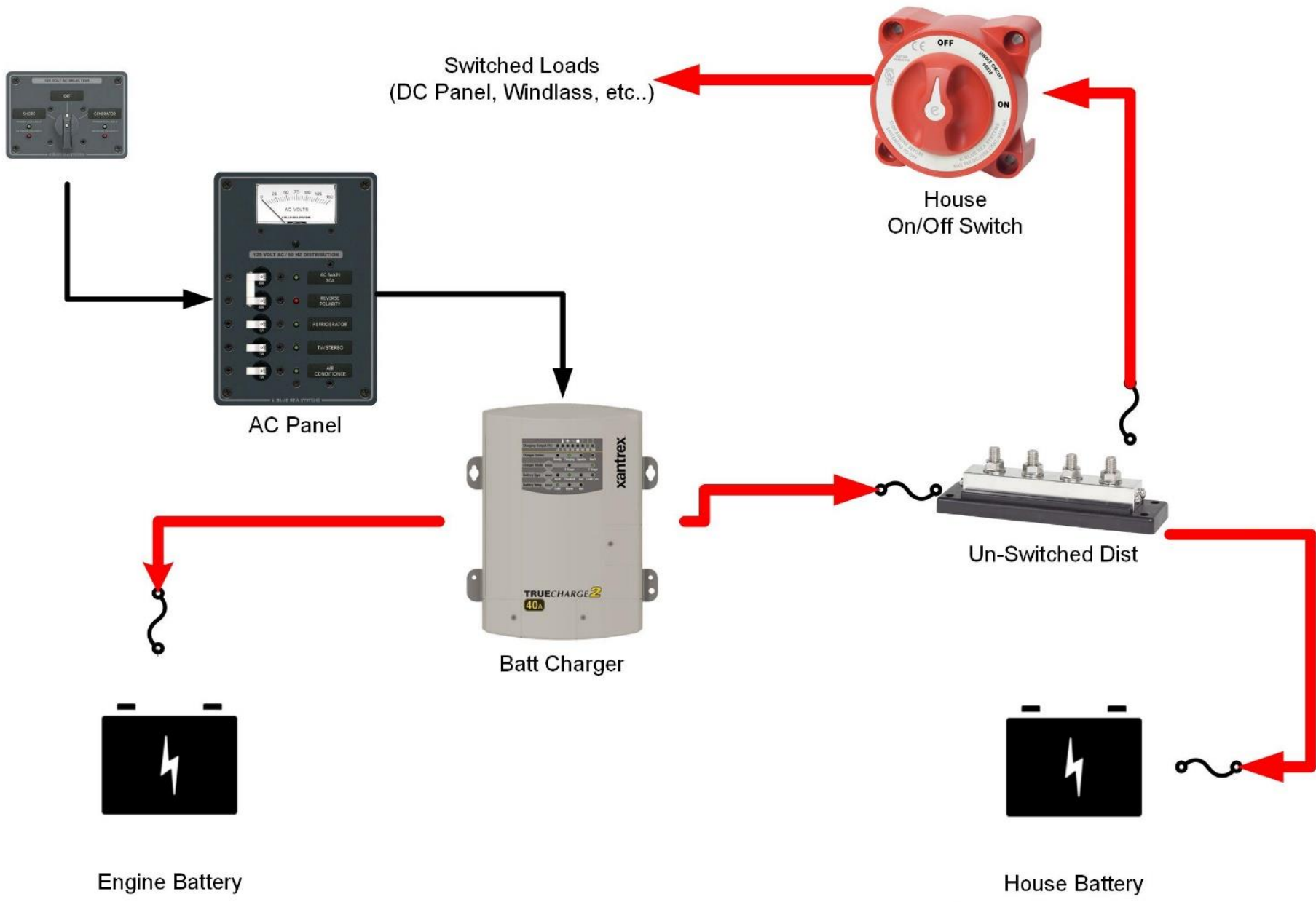

Charger: Design Tips



- Size charger at least 10% of house battery capacity
- Fuse leads at battery
- Connect directly to battery
 - (NOT switched)
- AC breaker size to handle bulk mode



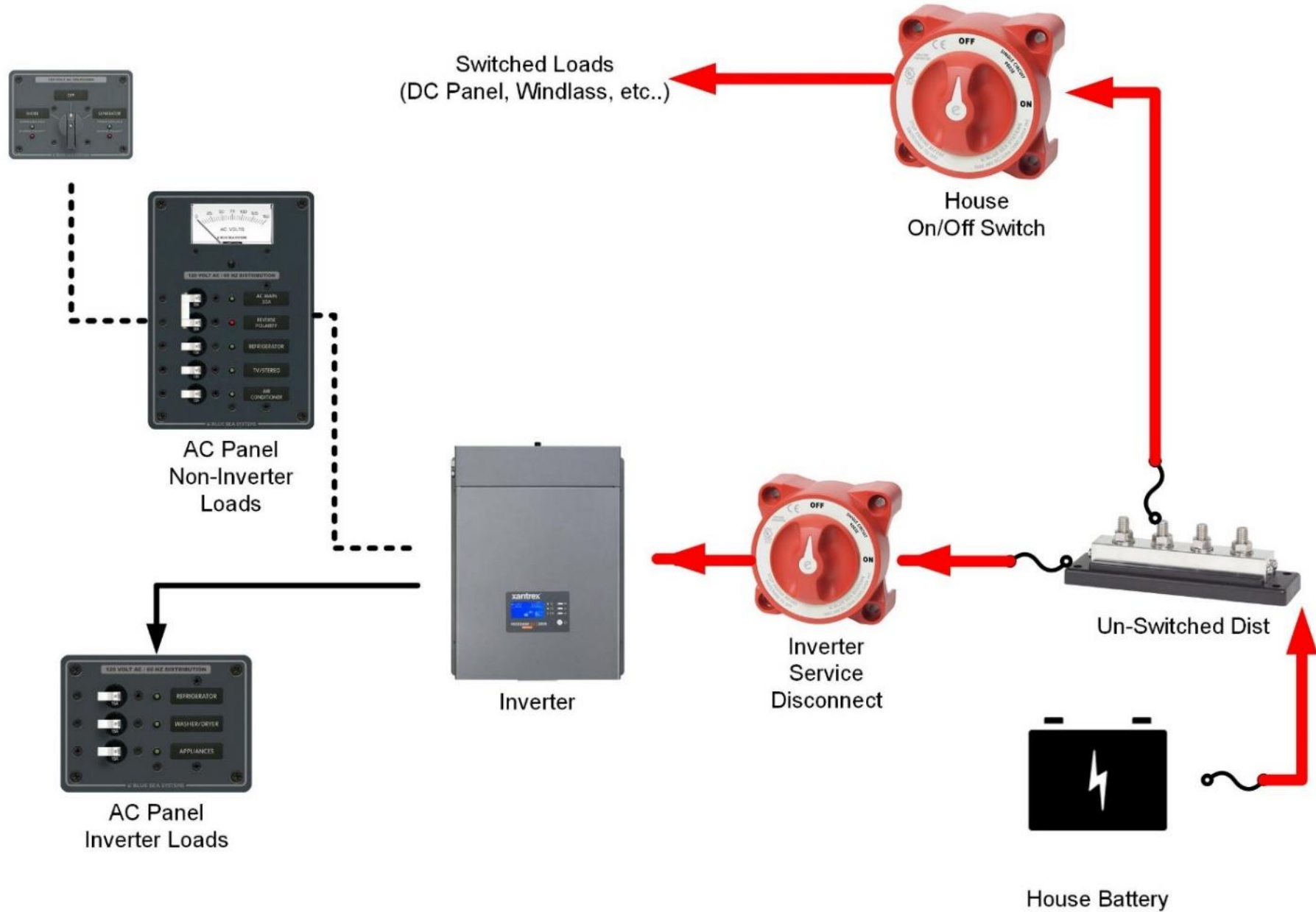

Inverter/Charger: Design Tips



- Class T fuse
- On/off master DC service disconnect
- Inverter-only neutral bus
- Chassis ground wire size
- DC wire size based on voltage drop and amps
- Location of inverter



Standard Alternator Wiring

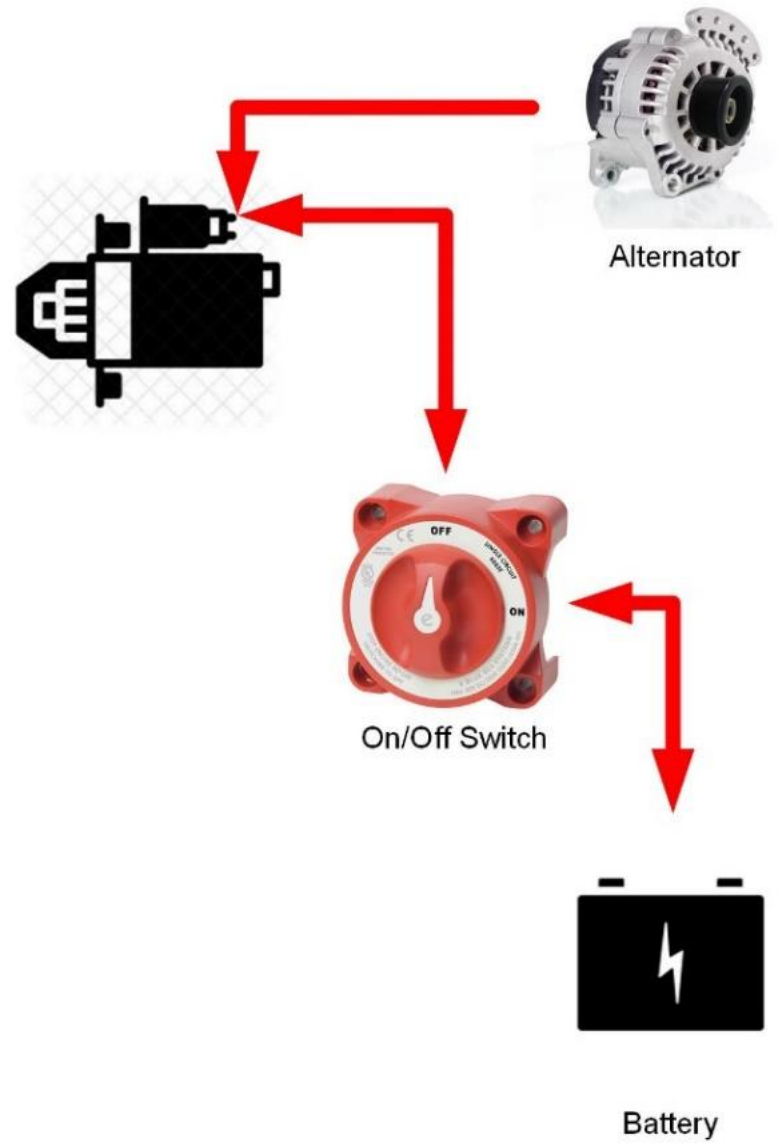

Improved Alternator Wiring

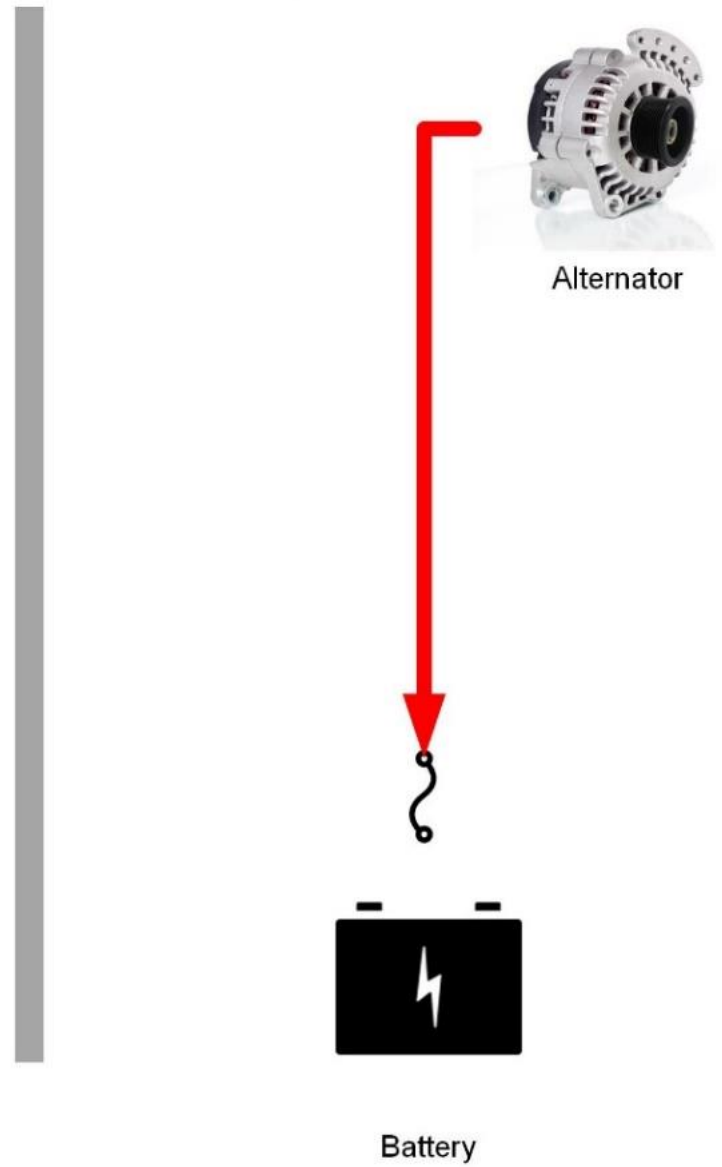

Alternator: Design Tips



- Size alternator for house battery bank size
- Size wires to handle amps
 - Positive and negative
- Fuse alternator wire

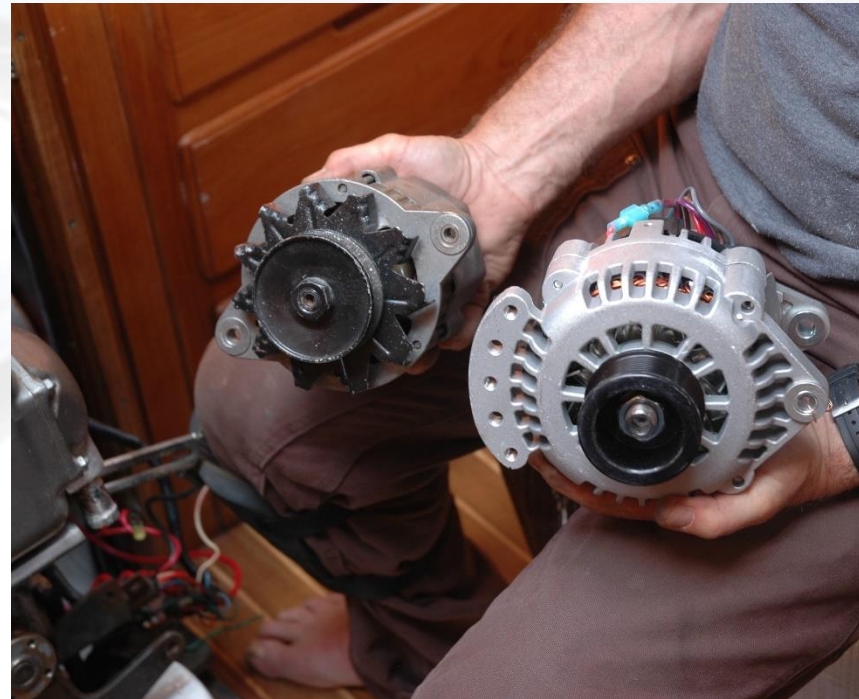

Single Solar Panel

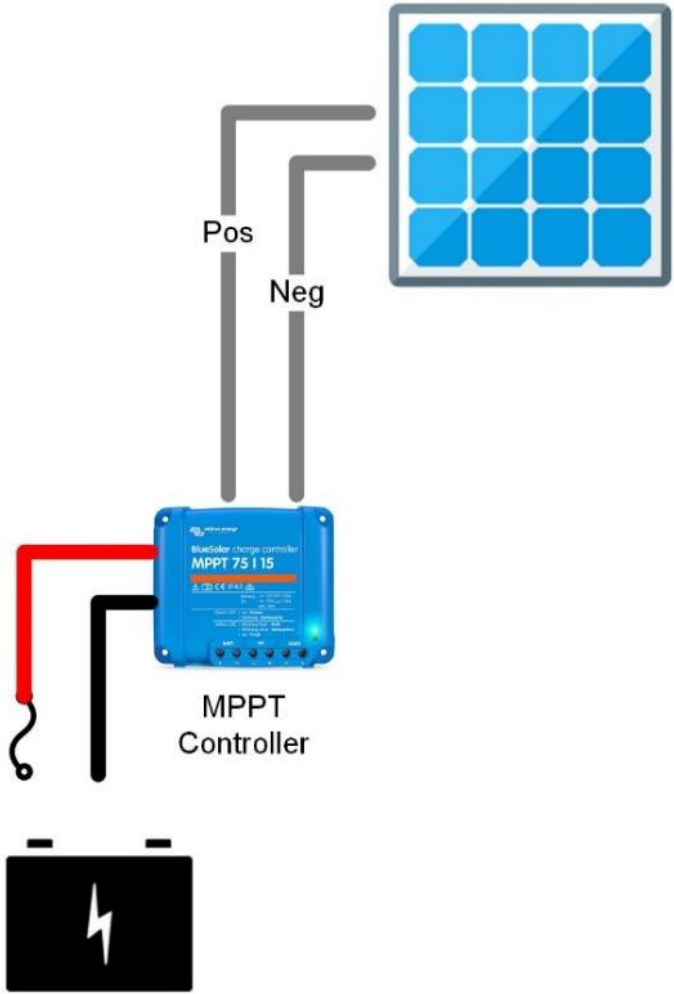

Battery

Solar Panels in Series

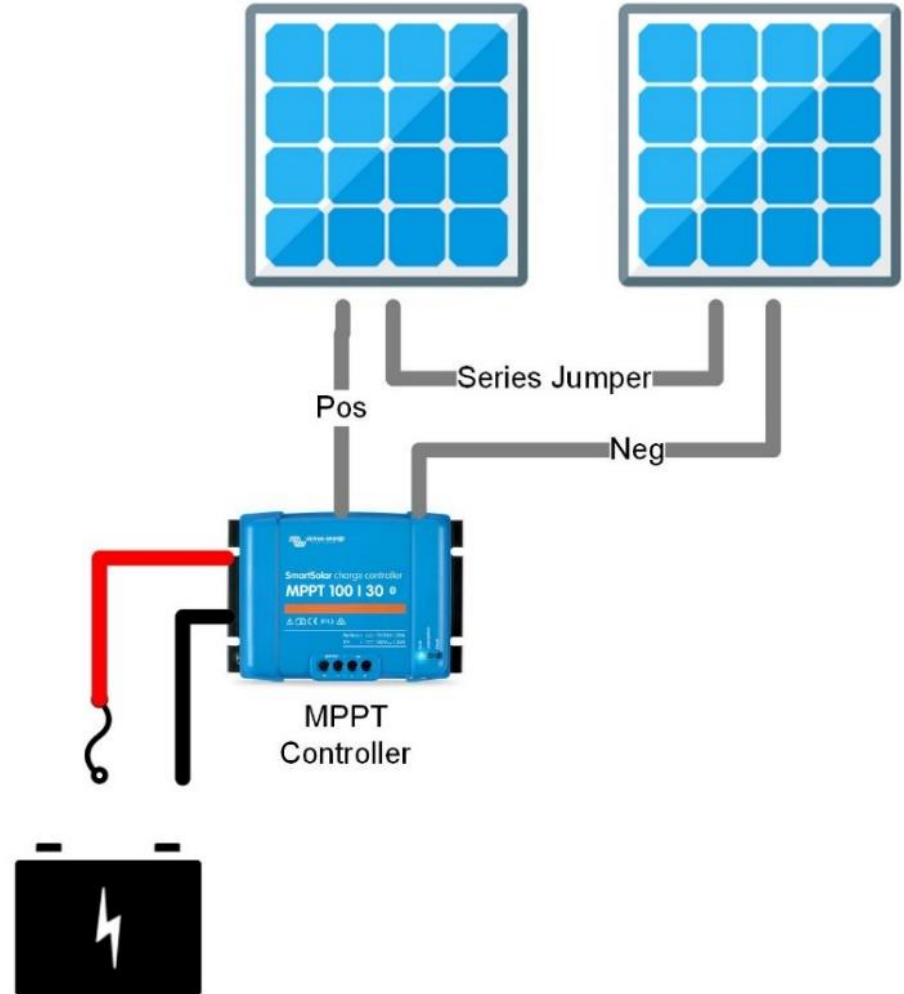

Battery

Solar Output: Quick Calculation



- Rule of thumb: 25% of wattage = daily Ah output
 - Watts X 25% or Watts / 4
 - E.g. A 100 Watt panel will produce 25 AHr
 - $100 \times 20\% = 25 \text{ Ah}$
- Optimistic: factor of 3 (i.e. 33 AHr)
- Conservative: factor of 5 (i.e. 20 AHr)

Solar Panels: Design Tips



- Battery voltage: 12 or 24 VDC?
- Maximum solar array Amperage & Voltage
- Battery chemistry
 - FLA, AGM, Lithium, custom
- Shade potential: consider one MPPT controller per panel
- Bring 10 gauge wire from solar panel to MPPT
- Fuse each panel and each individual load
 - Properly label all fuses and wire runs

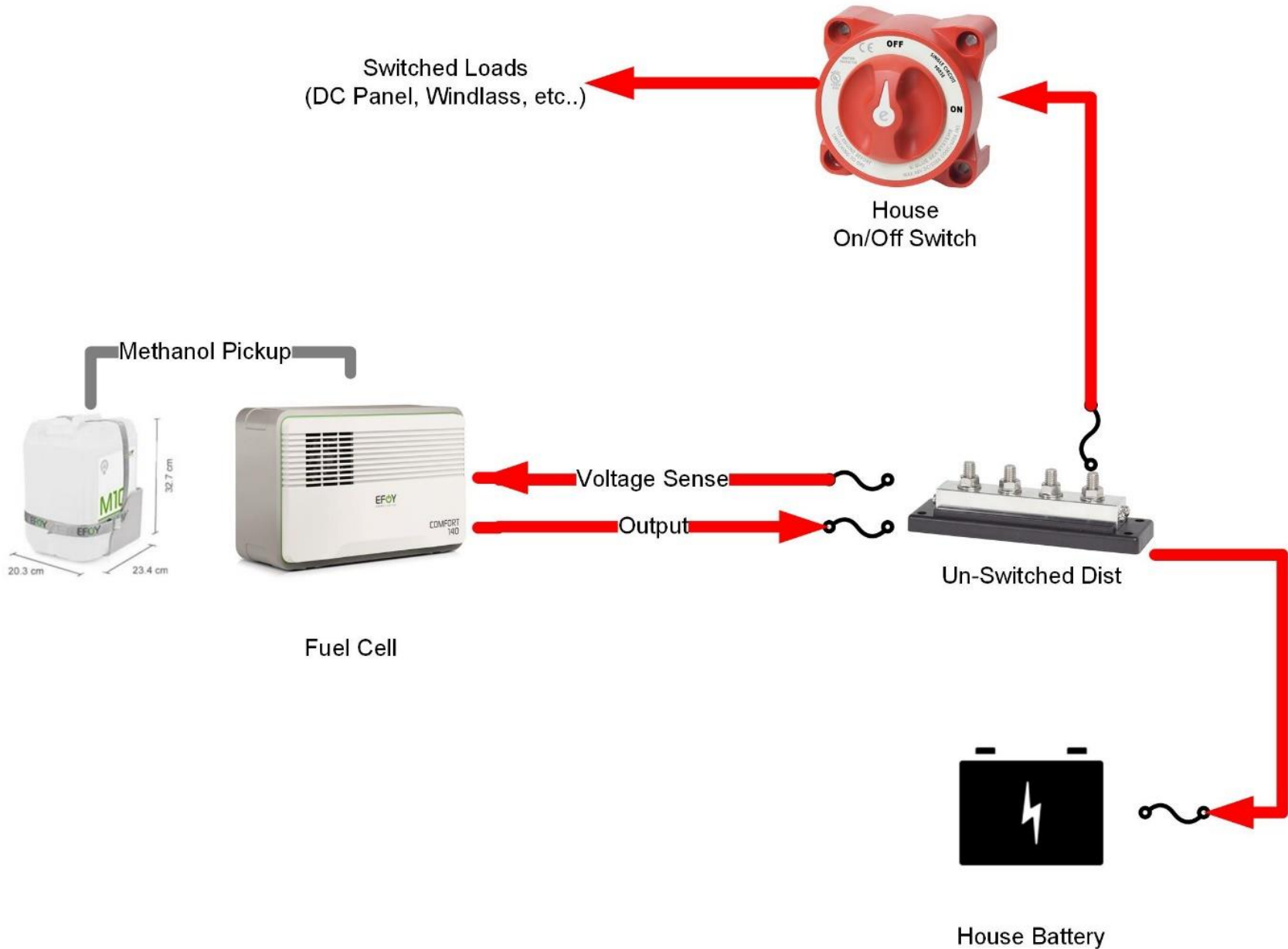

Methanol Fuel Cell: Design Tips



- Unit needs some ventilation
- Outputs distilled water
 - Water container or bilge?
- Fuel cartridge needs to be close to unit
- Select DC cable based on distance to battery





Power Sharing

Battery Combiners

Battery Isolators

Conceptual Diagram – DC Overview

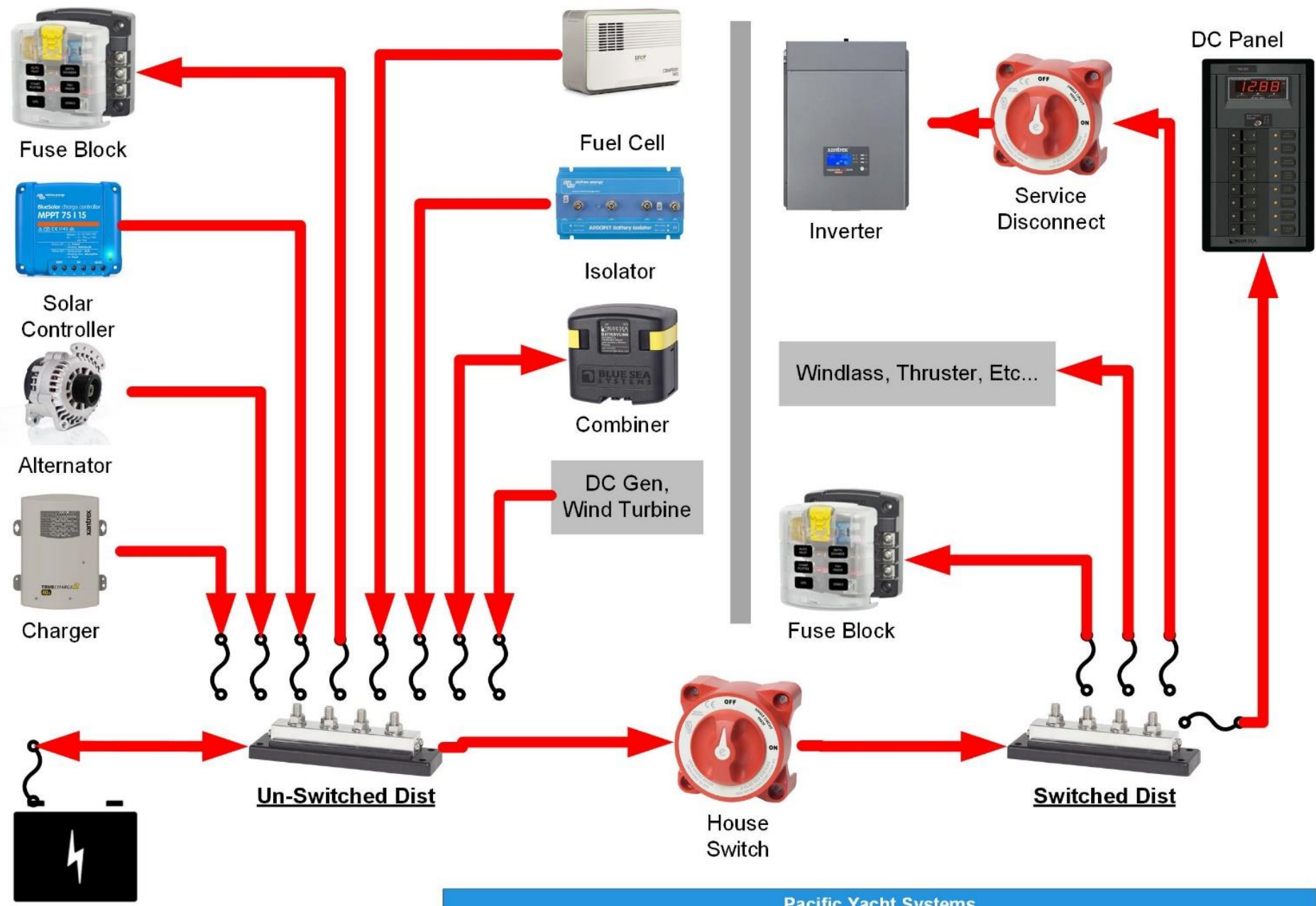

House Battery

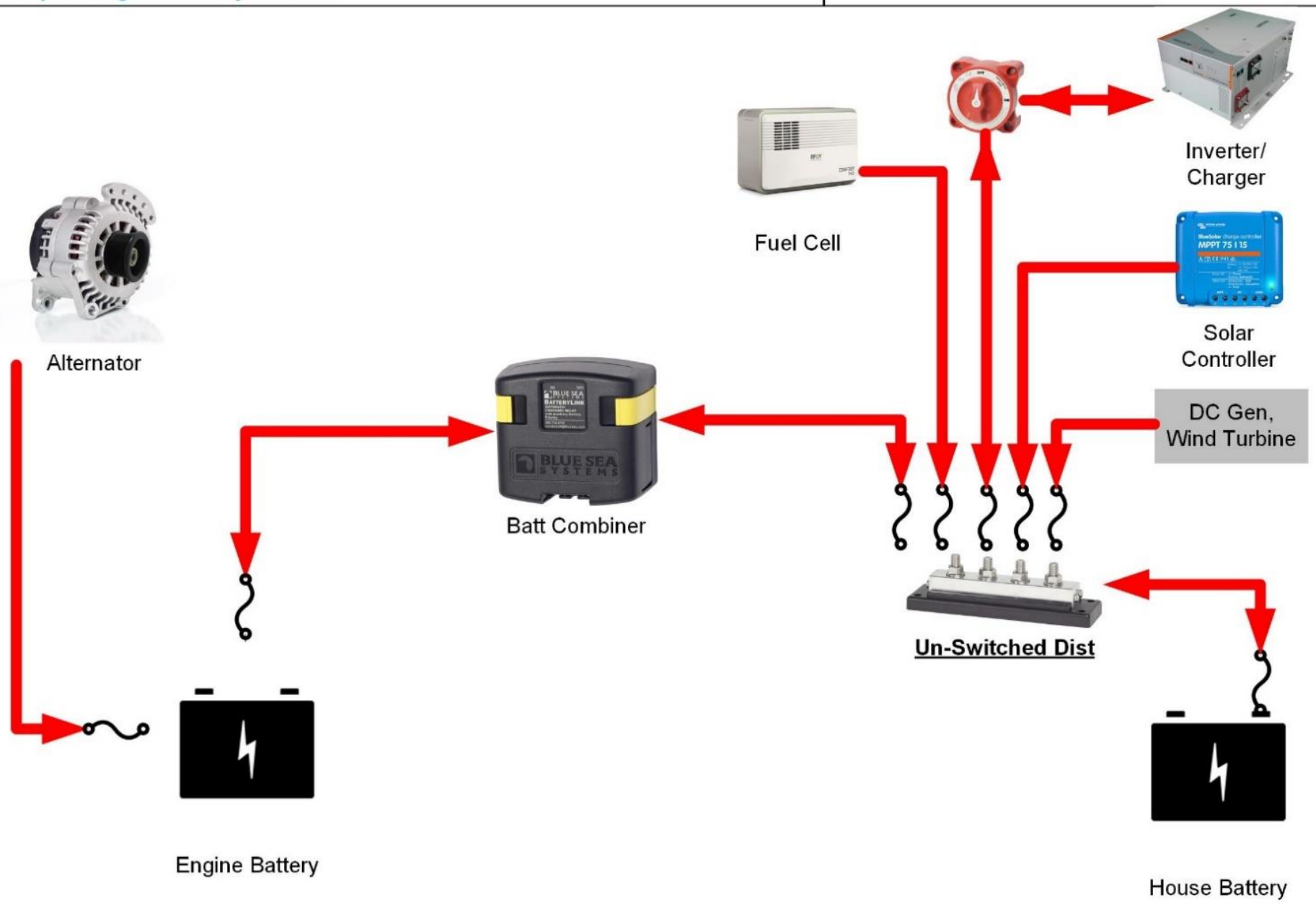

Battery Combiner: Design Tips



- Amperage for application, e.g. 55, 120, 300, etc...
- Fuse for maximum amperage at each battery
- Wire to batteries (NOT after switch)
- Fuse ground sense connection
- Battery bank should be similar in size



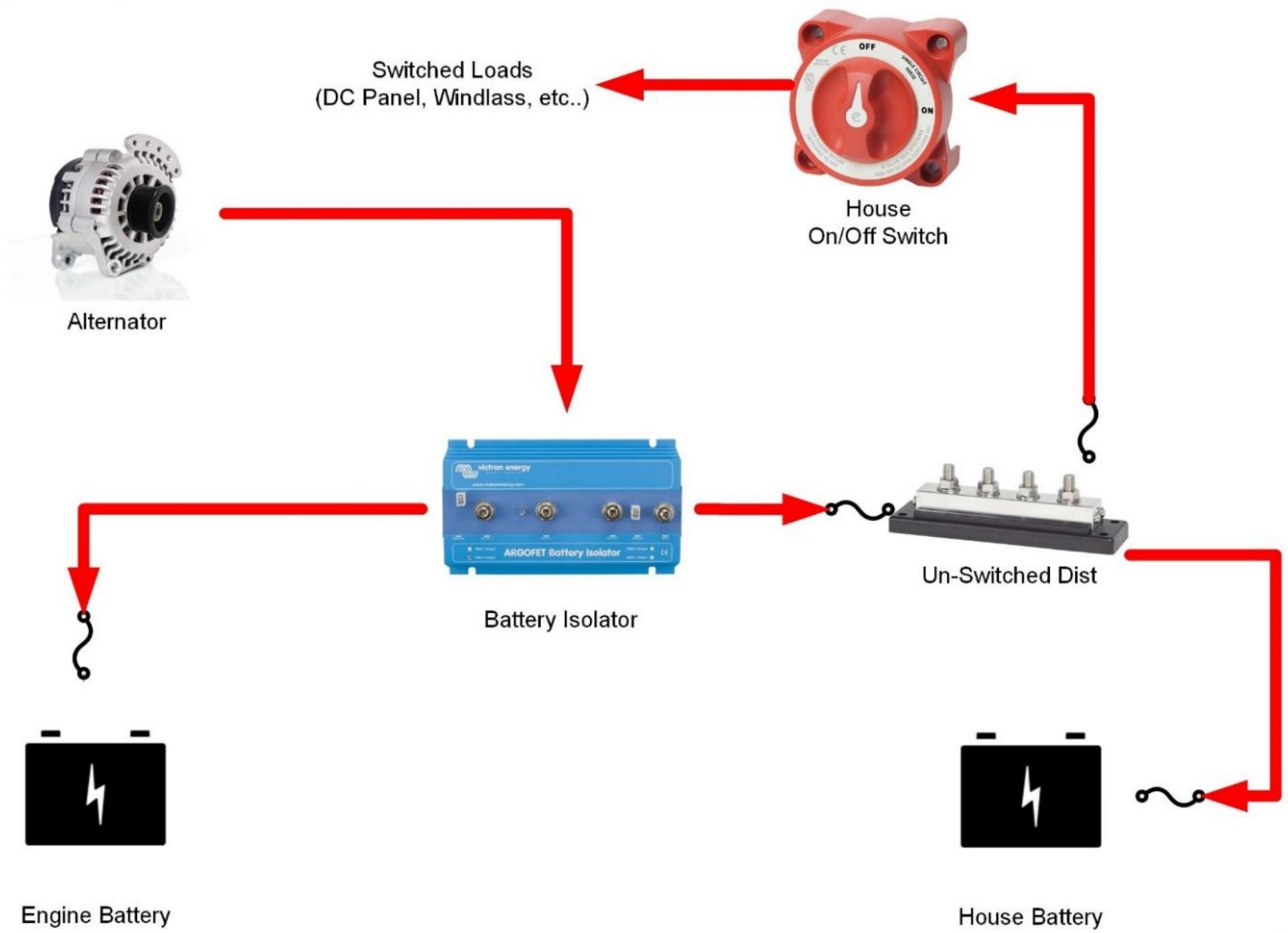

Battery Isolator: Design Tips



- Fuse alternator leads at batteries
 - Size to avoid nuisance tripping
- Size alternator cable to minimize voltage drop & alternator output amperage
 - E.g. 3% is good Voltage drop target
- Some models require ignition power and alternator field

Connect with PYS



- PYS Electrical Orientation for your boat
 - 90 mins: Batteries, DC distribution, charger, alternator, inverter
- PYS Design Services for DIYers
 - Electrical system designed by PYS (collaborative and to marine code)
 - Installed by yourself or other outfit
- Pacific Yachting magazine - Monthly Tech Talk Column
- Northwest Yachting – Monthly Hot Wire
- YouTube – 1.2Million Views
- www.pysystems.ca 1000s of articles
- Monthly email newsletter



Questions?

Conceptual Diagram – DC Overview

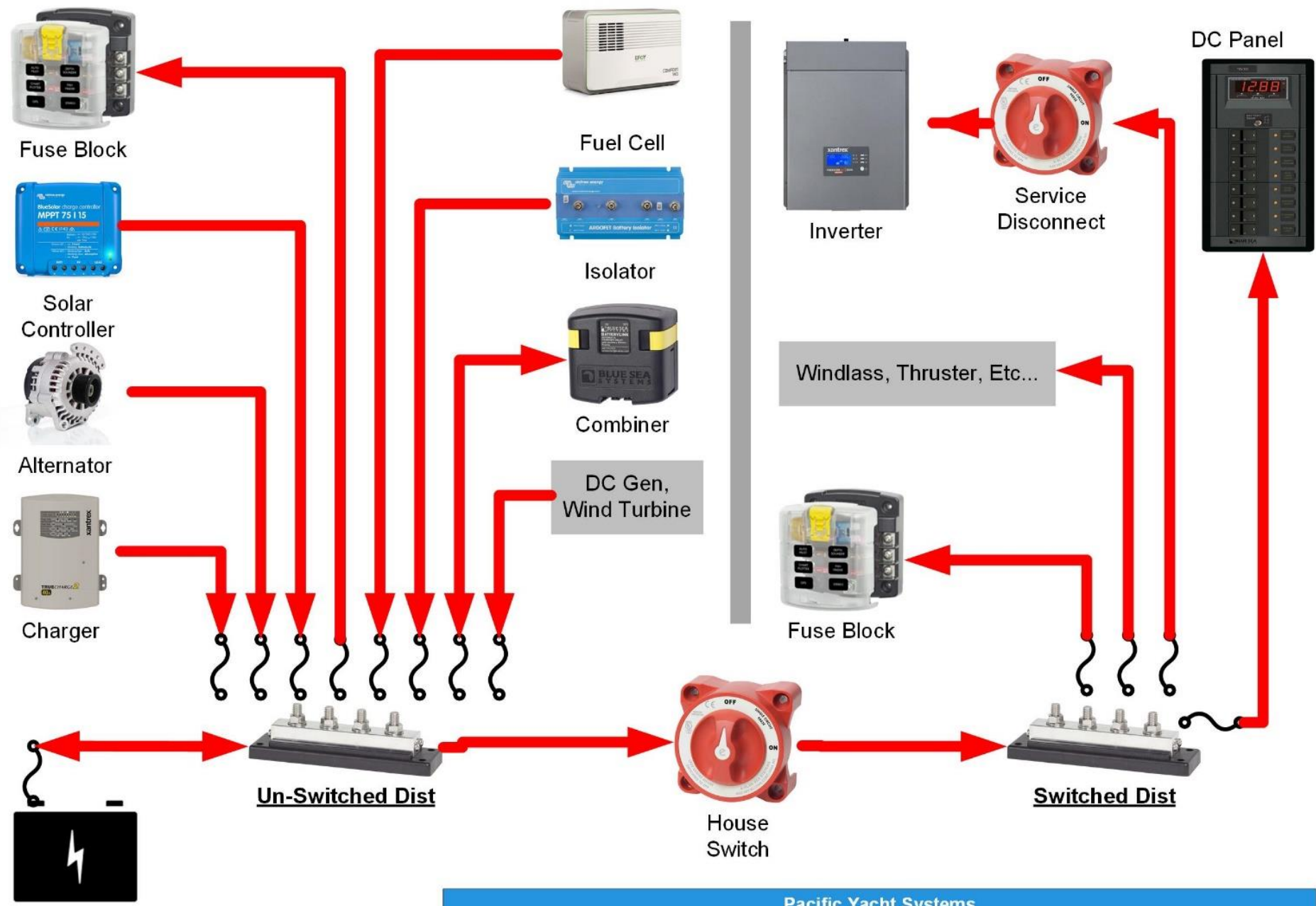

House Battery

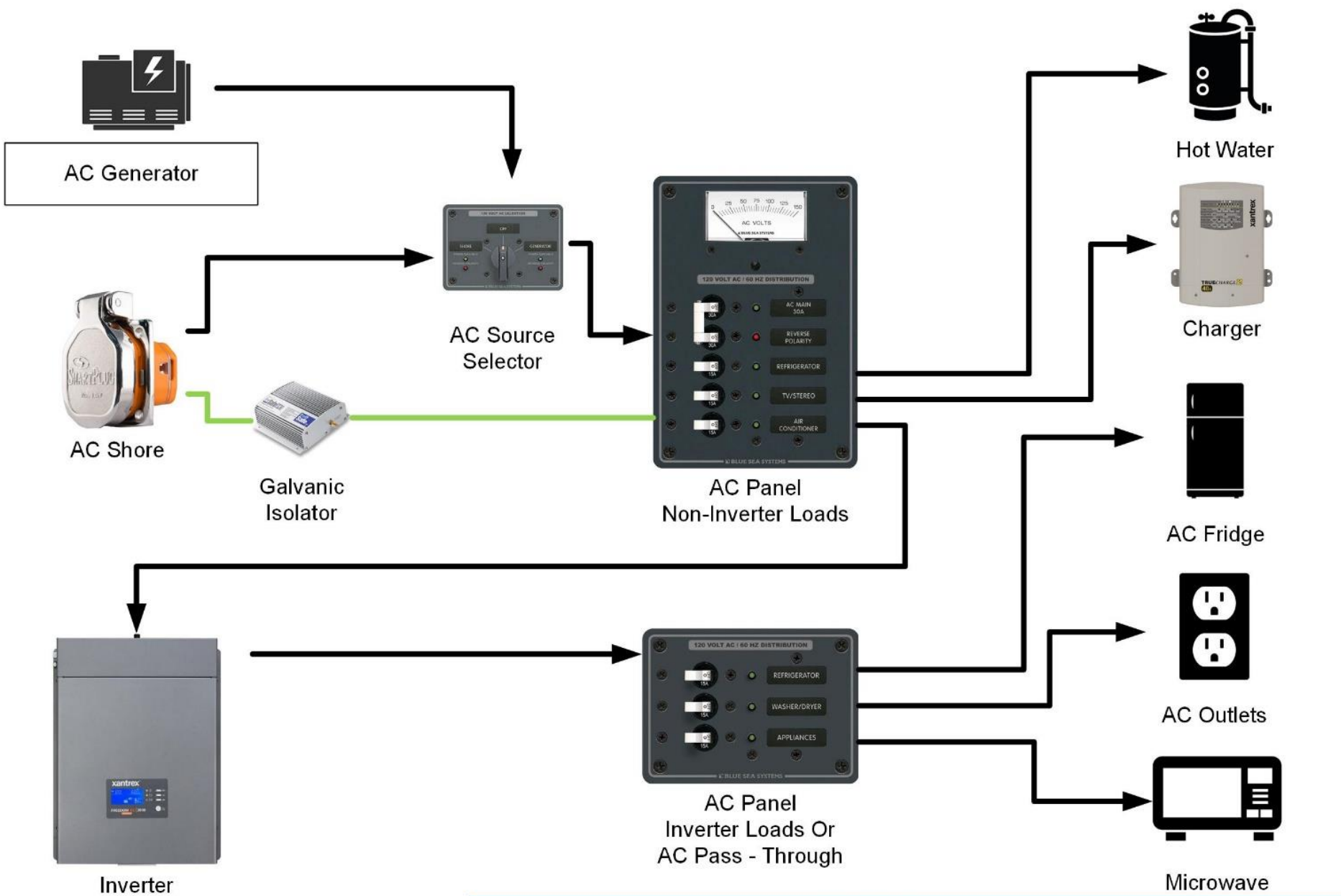

Feedback



Pacific

Yacht Systems
marine electronics & electrical

Full-service shop delivering
marine electrical and navigation
solutions tailored to your vessel
and your boating needs.

boating made simple
by design

design • installation • service • support

p | 604-284-5171 w | www.pysystems.ca

a | 1641 Powell Street, Vancouver, BC V5L 1H5